

Handheld Multi Gas Detector Operating Instructions

Model: CM501, CM503, CM504, CM505, CM506, CM507, CM510

Product Overview

Disclaimer! Please note, dependent on purchased model, some functionalities differentiate based on sensor configuration.

Thank you for selecting CM-500 handheld multi gas detector. With long-term data storage, the CM-500 is designed to simultaneously measure multiple gas concentrations in the ambient environment. When CM-500 measures the gas concentration reaching the alarm setting or higher, the data display and alarm functions are activated. CM-500 is equipped with an RS485 interface for connecting to a computer for remote monitoring to reduce the risk of exposure to high concentrations of harmful gases and avoid harm to human health. The Handheld Gas Detector can be used in a wide range of industries, which include paint-related industries, wineries, related industries of CO₂, food industry, laboratory, construction industry, etc.

Features:

- ☑ NDIR (CO₂), EC (CO, NH₃), and Fluorescence quenching by Oxygen (O₂) is used to measure gas concentrations.
- ☑ Measurement items:
 - Basic: CO₂, CO, PM2.5, PM10, RH, DP, AMB, Barometer
 - Optional: O₂, NH₃
- ☑ Large LCD for easy reading of gas concentration and temperature and humidity.
- ☑ Audible alarm
- ☑ Data logging with SD card
- ☑ Through the RS485 interface connection, multiple CM500 units can be connected to the back-end computer system as a security monitoring application.
- ☑ Built in the LCD backlight for easy reading in the dark.
- ☑ This device is supplied with Li- ion 18650 3.7V rechargeable batteries, can be used for a long time.

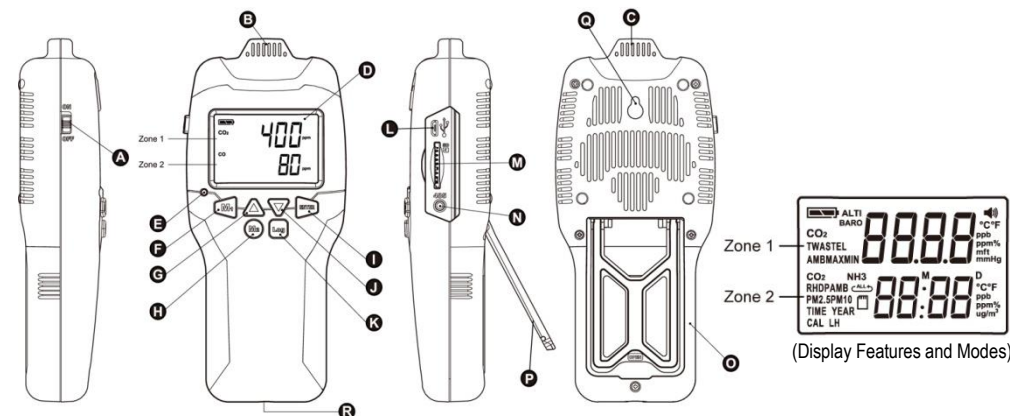

- A. Power Key
- B. Humidity Sensor
- C. Temperature Sensor
- D. LCD
- E. Charge Lamp
- F. M1 (Zone 1 Mode Key)
- G. UP/TWASTEL/Max/Min
- H. M2 (Zone 2 Mode Key)
- I. Enter
- J. DOWN/ALTI
- K. Log (Data Logger)
- L. USB Socket
- M. SD Card Slot
- N. RS485 Jack
- O. Battery Cover
- P. Stand
- Q. Screw Position
- R. Tripod Screw

Key description:

| | |
|------------------|---|
| M1 (Ⓜ) | Zone 1 sensor selection (CO ₂ , CO, O ₂ , AMB) |
| M2 (Ⓜ) | Zone 2 sensor selection (CO ₂ , CO, O ₂ , NH ₃ , RH, DP, AMB, PM2.5, PM10) |
| ▲ (Ⓜ) | TWA (CO ₂ , 8-hr time weighted average), STELL ON DEVICE, (CO ₂ , 15 min. weighted average), MAX, MIN |
| ▼ (Ⓜ) | ALTI (Atmospheric pressure) |
| Enter (Ⓜ) | Execute a command or select options. |
| Log (Ⓜ) | Data logger |

LCD display symbol description:

| Symbol | Description | Basic | Optional |
|---------|--|-------|----------|
| | Buzzer On | | ○ |
| 400 ppm | CO ₂ concentration, parts per million (ppm) | | ○ |
| 80 ppm | CO concentration, parts per million (ppm) | | ○ |

| | | | |
|------------------|----------------------|---|---|
| PM2.5 | 18 ug/m ³ | PM2.5 dust concentration (μg/m ³) | ○ |
| PM10 | 18 ug/m ³ | PM10 dust concentration (μg/m ³) | △ |
| O ₂ | 20.08 % | O ₂ concentration (%) | △ |
| NH ₃ | 90 ppm | NH ₃ concentration ppm (parts per million) | △ |
| | | Battery capacity | ○ |
| ALTI BARO | | Atmospheric pressure | ○ |
| TWA | | Time weighted average (8 hours) | ○ |
| STELL | | Short-Term Exposure Limit (15 min. weighted average) | ○ |
| MAX | | Maximum value | ○ |
| MIN | | Minimum value | ○ |
| AMB | | Ambient temperature | ○ |
| RH | | Relative humidity | ○ |
| DP | | Dew point | ○ |
| TIME | | Real-time setting display | ○ |
| YEAR | | Year display | ○ |
| CAL L H | | High/low gas concentration calibration | ○ |
| AL L H | | High/low gas concentration alarm | ○ |
| | | Display cycle | ○ |
| | | SD card | ○ |

Operation Instructions

Power on:

Switch the Power Key (A) on.

Measurement:

After power on, the device starts to measure and update the data every second. Press the "M1" key (Ⓜ) to switch the Zone 1 sensor display. (CO₂→CO→O₂→AMB)
Press the "M2" key (Ⓜ) to switch the Zone 2 sensor display. (CO₂→CO→O₂→NH₃→RH→DP→AMB→PM2.5→PM10)

°C/°F switch:

When the temperature is displayed on the screen, press the "▲" key (Ⓜ) to switch °C/°F.

Backlight:

The backlight appears on the screen during startup and operation. After the device is idle for 30 seconds, the backlight is automatically turned off to extend battery life.

Display all sensor readings

Press the "M2" key (Ⓜ) for more than 3 seconds and the screen displays . Zone 2 displays readings of all sensors sequentially in time intervals. If you need to increase the display interval time, long press the "M2" key (Ⓜ). The interval time will automatically increase (1+0.5+0.5..... max. 10 seconds), and release the "M2" key (Ⓜ), the readings will be displayed according to the last set interval. If press the "M2" key (Ⓜ) again for more than 3 seconds, the function can be cancelled.

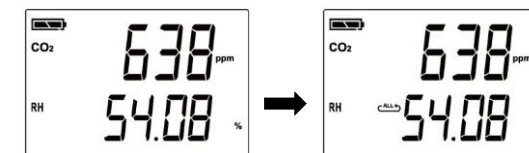

Real-time setting:

Long press the "M1" key (Ⓜ) to proceed the date and time setting. The default format is 24-hour. Press the "▲ (Ⓜ)/▼ (Ⓜ)" key to edit the parameters, and press the "Enter" key (Ⓜ) to proceed the next setting. The setting sequence is: year→month→day→hour→minute. After finishing the real-time setting, press the "M1" key (Ⓜ) to continue the alarm setting.

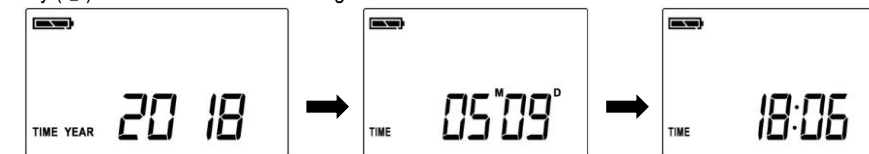

Alarm settings:

The setting order of the sensors is CO₂→CO→O₂→NH₃→PM2.5. Press the "Enter" key (Ⓜ) to switch the high/low gas concentration alarm setting. Press "▲ (Ⓜ)/▼ (Ⓜ)" key to edit the parameters, and then press the "M1" key (Ⓜ) to proceed the next sensor alarm value settings. After settings, press and hold the "M1" key (Ⓜ) to return to the main screen.

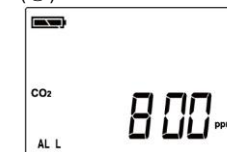

Data logging:

Press the "Log" key (Ⓜ) for 3 seconds and the screen displays to start the data logging function, long press the "Log" key (Ⓜ), this function can be canceled. When flashes, it means that the SD card is broken or full; when remains stationary, it indicates normal operation.



Data logging interval time setting:

The default interval time is 00:02 (2 seconds). Press the "Log" key (Ⓜ) for more than 3 seconds and then the interval time will automatically increase. The interval time, loop display, ranges from 00:02 seconds to 60:00 minutes and then back to 00:02 seconds. The interval time ≤5 minutes, the buzzer on/off switch is controlled by the "Enter" key (Ⓜ); the interval time is ≥5 minutes, the buzzer is off.

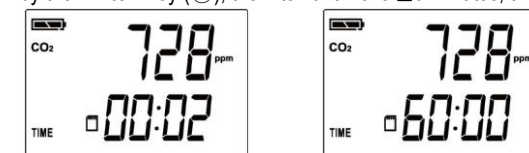

Atmospheric pressure display:

Press "▼" key (Ⓜ), to show barometric pressure.

Atmospheric pressure compensation:

Press and hold the "▼" key (Ⓜ) to turn the compensation function on/off. The gas compensation is only for CO₂ and O₂.



Buzzer on/off:

Press the "Enter" key (Ⓜ) to turn the buzzer on/off. During operation, if AL L or AL H buzzer sounds, stops to operate. At this time, press the "Enter" key (Ⓜ) to turn off the buzzer and continue . In addition, the buzzer will be automatically turned off when the data logging interval time is ≥5 minutes.



Buzzer AL L/AL H:

When **AL L** is on, the buzzer sounds "Ta Ta Ta"; when **AL H** is on, the buzzer sounds "Bi Bi Bi".

RS485 communications:

Please use the 4 Pole 3.5mm headphone plug. The headphone plug contacts are defined as below:

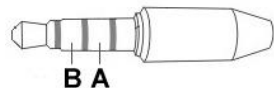

For long-distance communication, it is necessary to use a dedicated isolated line to ensure communication quality. The wiring method is as below:



Power off:

Switch the Power Key (A) off.

Note: When the device is charged with USB, it cannot be turned off.

Calibration:

(1) Single-point calibration

At the same time, long press "▲ (G)" and "▼ (J)" key, **CAL** is displayed on the screen. Press the "M1" key (E) to select the sensor that needs to be calibrated. Press the "▲ (G)/▼ (J)" key to edit the parameters, and then press the "Enter" key (I) to proceed the next setting. Zone1 displays the unadjusted raw value; Zone2 displays the adjusted value, and it is also the value of returning to the main screen; Zone1-Zone2=adjustment amount. After finishing the setting, press and hold the "M1" key (E) to return to the main screen.

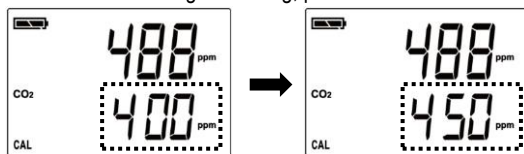

(2) Two-point calibration

At the same time, long press "▲ (G)" and "▼ (J)" key, **CAL** is displayed on the screen. And then long press the "M2" key (H), **CAL L** is displayed on the screen. Next, press the "M1" key (E) to select the sensor that needs to be calibrated (CO2→CO→O2→NH3→PM2.5→RH→AMB) and the corresponding unit will blink. Press "▲ (G)/▼ (J)" key to adjust the value of the standard gas concentration. Press "Enter" key (I) to switch **CAL H** (High gas concentration calibration)/**CAL L** (low gas concentration calibration). The ppm unit is not flashing for a moment, indicating that the calibration value has been stored. Long press the "M2" key (H) for a calibration calculation. At the same time, the screen displays the calibration reading to confirm the accuracy. Short press the "M1" key (E) to set the next gas calibration, or long press the "M1" key (E) to return to the main screen.

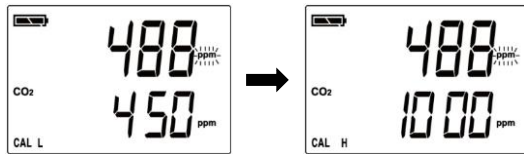

Clear Two-point calibration:

Set the same calibration value for **CAL L** and **CAL H**, and then proceed the calculation. After the calibration is completed, the original calibration value is cleared.

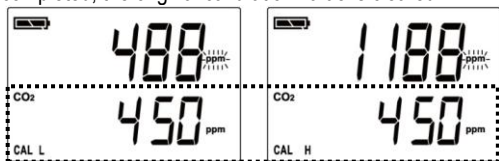

Rechargeable Batteries

Battery message:



'Battery OK':

Measurements are possible



'Battery Low':

The battery needs to be recharged, measurements are still possible



'Battery Exhausted':

Measurements are not possible

Battery installation:

This device is supplied with Li-ion 18650 3.7V rechargeable battery *3 pcs.

Please confirm whether batteries + polarity are Li ion 18650 positive bump specification and install batteries in the correct polarity. If the battery polarity is reversed, the capacity will be insufficient and the battery life will be shortened.

Battery charging:

The charge lamp (E) lights up while charging; the charge lamp (E) goes off when charging is completed. (5V/1A USB adapter charger)

Note: During battery charging, the temperature of the device will rise by 5°C~10°C. At this time, the measurements of temperature and humidity will be affected by temperature rise. Cause an impact on the accuracy of temperature when charging, please use a fan to blow toward the temperature sensor (C) directly in order to get a compensated balance of temperature and humidity between temperature sensor and surrounding area.

Safety Instructions

Warning: Your safety is very important to us. To ensure to use the device correctly and safely, we would like to draw your attention to read the warning and entire User Manual before using the device. These are important safety information and should be observed at all times.

1. Please handle the device lightly, do not subject the device to impact or shock.
2. Do not immerse the device in water. Water can cause electric shock, fire or malfunction which may result in damage.
3. Do not keep the device under the hot and moisture environment. Keep the device away from the heat source or near water.
4. Please use a standard USB power supply (such as PC's USB port, universal AC adapter with USB port). Improper power supply can cause serious damage to the device, or result in injury or death to the user.

Product Care

To ensure you receive the maximum benefit from using this device, please observe the follow guidelines.

1. The maximum capacity of the SD card is 16G.
2. During battery charging, the temperature of the device rises. The temperature and humidity sensors are affected. At this time, measurements are only for reference. After batteries are fully charged and the device cools down, measurements are reliable.
3. **Repair** – Do not attempt to repair the device or modify the circuitry by yourself. Please contact with the local dealer or a qualified repairman if the device needs servicing.
4. **Caution** – The CO and NH3 sensors must be replaced every 3 years.
5. **Cleaning** – Disconnect the power before clean. Use a damp cloth, do not use the liquid cleaning agent, such as benzene, thinner or aerosols.
6. **Maintenance** – Recommend that the user conducts a comprehensive test and calibration every year to ensure the normal operation of the device.

Specifications

| | Measurement Range | Accuracy | Display Resolution |
|---------------------------------------|---|--|---------------------|
| CO ₂ | 0~9,999ppm (5,001~9,999ppm over range) | ±50ppm or 5% of reading, whichever is greater (0~5,000ppm) | 1ppm |
| CO | 0~1,000 ppm | ±5%~±10% | 1ppm |
| O ₂ | 0~25% | <2% FS/0.1 mbar | 0.01% |
| NH ₃ | 0~100ppm | ±10% | 1ppb |
| PM _{2.5} PM ₁₀ | 999 ug/m ³ | ±15% or ±15 ug/m ³ , whichever is greater | 1 ug/m ³ |
| RH | 0~100% RH | ±3%@25°C (20~80% RH), others ±5% | 0.01% |
| Temperature | 0~50°C | ±1°C | 0.01°C |
| Barometer | 50~110 kPa | ±0.4kPa | 0.1 mmHg |
| Operating Conditions | 0~40°C (32~104°F), 0~95% RH, non-condensing, with lithium-ion batteries 0~50°C (32~122°F), 0~95% RH, non-condensing, without lithium-ion batteries | | |
| Storage Temp. | -20~60°C (-4~140°F), 0~85% RH, non-condensing, without lithium-ion. batteries | | |
| Power Supply | Rechargeable Battery : Li-ion 18650 3.7V *3 (batteries not included) AC Adapter : 5V±5% >1A, 100~240 VAC, 50/60 Hz | | |
| Storage Capacity | depend on SD card capacity (max.16G SD card) | | |
| Comm. Interface | RS485 ModBus BR19200 · N · 8 · 1 | | |
| Alarm | 80db±5%@10cm | | |

| | |
|-----------|-------------------------------------|
| Volume | |
| Weight | 305g (without batteries) |
| Dimension | 204.5x91.7x49.6 mm (8.1x3.6x2 inch) |

Note: After power-on, it would take 20 minutes for the device to stably measure the temperature and relative humidity.

EMC/RFI: Readings may be affected if the unit is operated within radio frequency electromagnetic field strength of approximately 3 volts per meter, but the performance of the instrument will not be permanently affected.

Sensor warm-up time and logging Interval:

| No. | Sensor | Warm-up time | Data logging interval time setting | |
|-----|---------------------------------------|--------------|---|------------------------------------|
| | | | After powering on and standby time, data logging can be operated. | Data logging interval time setting |
| 1 | CO ₂ | < 1 minute | After power on 5 minutes | 2 seconds~60 minutes |
| 2 | CO | 5 minutes | After power on 5 minutes | 2 seconds~60 minutes |
| 3 | O ₂ | < 1 minute | After power on 5 minutes | 2 seconds~60 minutes |
| 4 | NH ₃ | 5 minutes | After power on 5 minutes | 2 seconds~60 minutes |
| 5 | PM _{2.5} PM ₁₀ | < 1 minute | After power on 5 minutes | 2 seconds~60 minutes |

Installation Instruction

1. You can put CM-500 on the table (please pull out the Housing Stand (P)) or hang it on the wall.
2. Please note the following when hanging it on the wall. Choose a suitable location to install CM-500, fix a screw to the wall.

Package contents

Handheld multi gas detector
Manual
USB 1.5M cable
SD Card

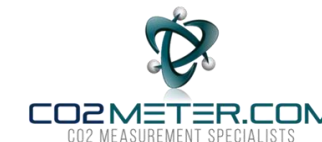

CO2 Meter, Inc.
131 Business Center Drive,
Ormond Beach, FL 32174
Sales@CO2Meter.com www.co2meter.com



Ref.No. : 122018