

# QUICK START GUIDE

CO2Meter.com  
CO2 Measurement Specialists

**GASTRACK**  
Gas Analyzer Probe (GAP-100)

**1a.** Unpack the gas analyzer probe, accessories and documents. Ensure contents are correct, contact CO2Meter, if anything is missing.



**1b.** Transfer the device to a clean workbench.

**NOTE:** Read the User Guide BEFORE proceeding; the Quick Start Guide (this document) is for reference only.

**2.** If required, remove the head housing (1) from the probe body (2):

- Using a 10mm socket (or spanner), loosen clamp (3).
- Carefully withdraw the probe body from the head housing.

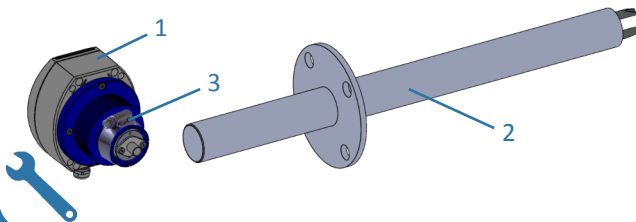

**3.** Measure the distance between the probe installation site and the controller, and cut cable to length.

**NOTE:** Leave enough cable length to ensure the probe can be removed from its location without stretching the cable.

**CAUTION:** Cable MUST be shielded.

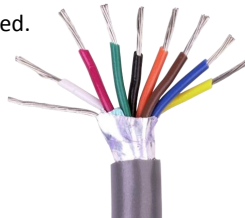

**4.** Remove the front panel (1) and set to one side:

- Loosen four captive screws (2) and carefully ease the front panel (1) from the housing.
- Disconnect the ribbon cable from the front panel (1).



**WARNING:** Shock hazard, do NOT apply power!

**5a.** Prepare your cable; shielding exposed and wire ends trimmed.

**5b.** Feed cable through the gland and wire connector.

**CAUTION:** Make sure the terminals are wired as shown; failure to connect power correctly could result in irreversible product damage that is NOT covered by warranty.

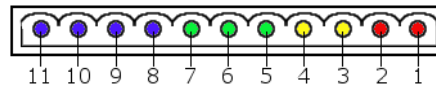

#### Power Supply

- PIN 1: 24V<sub>DC</sub>
- PIN 2: 0V

#### Digital Output

- PIN 3: COM1
- PIN 4: COM2

#### Analogue Output

- PIN 5: Analogue GND
- PIN 6: Analogue Out1
- PIN 7: Analogue Out2

#### Relay Output

- PIN 8: Relay 1 In
- PIN 9: Relay 1 Out
- PIN 10: Relay 2 In
- PIN 11: Relay 2 Out

**NOTE:** Do NOT leave any wires loose; accidental shorting may cause product damage.

**5c.** Carefully pull cable back through the gland until the connector aligns with the board; fit connector to the board.



Always handle the interface board using the correct ESD handling precautions.

**CAUTION:** Make sure the shielding is intact and correctly positioned to ensure the device is grounded properly.

**5d.** Using a 20mm spanner, tighten the cable gland to secure the cable in place.

**NOTE:** Be careful not to over-tension the wires or over-tighten the gland.

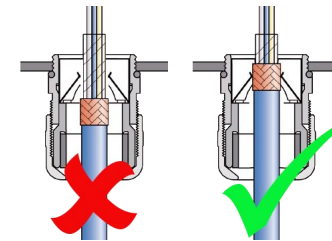

**6.** Fit the front panel and screw covers to the probe:

- Connect the ribbon cable to the front panel.
- Install the front panel (1) to the head housing and secure in place with the four captive screws (2).
- Fit the screw covers (3).



7. If required, assemble the head housing and probe body:

7a. If required, fit sensing module to the head housing;

- Ensure the gasket is in position in the head housing.
- Gently push sensing module to secure in place.

**NOTE:** The connector is keyed to aid alignment.

**CAUTION:** Do NOT force the sensing module otherwise you may damage the sensor and /or housing connectors.

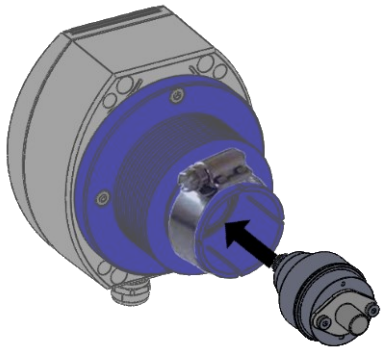

7b. Ensuring clamp (3) is fitted over the head housing shoulder and with the flow direction arrow (1) pointing upwards, carefully slide the probe body into the head housing (cable gland (2) at the base of the housing should face downwards).

**CAUTION:** Be careful not to damage the sensing module.

**NOTE:** Ensure the probe is inserted fully (housing shoulder aligns with the indicator line on the probe).

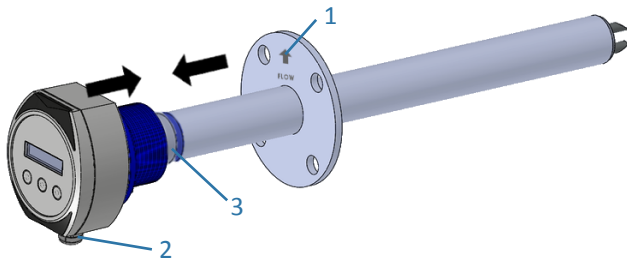

7c. Using a 10mm socket (or spanner) tighten clamp (3) to secure the head housing in position; torque to 5Nm.



8. With a suitable gasket in place, install the probe assembly into position and secure using the appropriate flange / mounting hardware.

**NOTE:** Ensure gas flow direction arrow is aligned correctly.

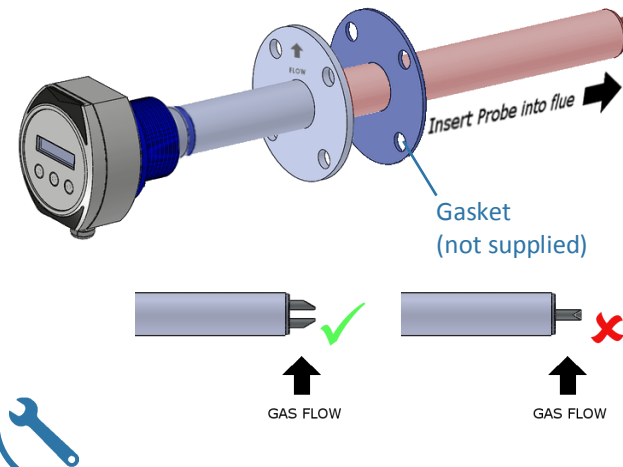

**WARNING:** Shock hazard, do NOT apply power!

9. Connect power and input/output connections to the controller:

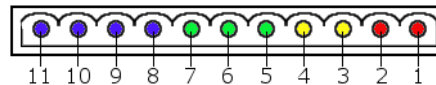

**Power Supply**

- PIN 1: 24V<sub>DC</sub>
- PIN 2: 0V

**Analogue Output**

- PIN 5: Analogue GND
- PIN 6: Analogue Out1
- PIN 7: Analogue Out2

**Digital Output**

- PIN 3: COM1
- PIN 4: COM2

**Relay Output**

- PIN 8: Relay 1 In
- PIN 9: Relay 1 Out
- PIN 10: Relay 2 In
- PIN 11: Relay 2 Out

**CAUTION:** Test the power supply to ensure it is “24V<sub>DC</sub> ± 10%” before wiring to the probe.

**CAUTION:** Failure to test the suitability of the power supply BEFORE first power ON could cause irreversible damage that is NOT covered by warranty.



10. Apply 24V<sub>DC</sub> to the device.

**NOTE:** Read the User Guide BEFORE proceeding; the Quick Start Guide (this document) is for reference only.



**Further information:**

Refer to *DS-GAP 100* for full details of how to install, configure, calibrate and maintain the device.

Need help? Ask the expert  
(877) 678 - 4259 or  
Support@CO2Meter.com



**CAUTION**

Do not exceed maximum ratings and ensure sensor(s) are operated in accordance with their requirements. Carefully follow all wiring instructions. Incorrect wiring can cause permanent damage to the device. Zirconium dioxide sensors are damaged by the presence of silicone. Vapours (organic silicone compounds) from RTV rubbers and sealants are known to poison oxygen sensors and MUST be avoided. Do NOT use chemical cleaning agents.

**Failure to comply with these instructions may result in product damage.**

**INFORMATION**

As customer applications are outside of CO2Meter's control, the information provided is given without legal responsibility. Customers should test under their own conditions to ensure that the equipment is suitable for their intended application.

For more information visit, [www.co2meter.com/pages/terms-conditions](http://www.co2meter.com/pages/terms-conditions)  
**For technical assistance or advice, please email:**  
[Support@CO2Meter.com](mailto:Support@CO2Meter.com)