

Oxygen Monitor Operating Manual

Model: RAD-0002 Remote Oxygen Storage Safety System

1. Product Description

Thank you for selecting the RAD-0002 Remote Oxygen Storage Safety System. This monitor is designed to detect oxygen depletion in enclosed spaces and to warn occupants of low oxygen levels. Low concentrations of oxygen (O2) in confined spaces are dangerous, and may lead to health problems ranging from headaches and fatigue to asphyxiation and death. This monitor has both audible and visual alarms which activate when the O2 concentration is lower than the pre-set alarm levels. Detection of low levels of O2 will also activate relays that can be used for a fan or air-handling system to ventilate the confined space and improve O2 concentration in the area.

The RAD-0002 O2 Monitor is cost-effective and has many features including:

1. Separate SEU (Main Sensor Unit) and RDU (Remote Display Unit) allow you to see warning before entering an enclosed area. Up to 3 RDUs can be used.
2. Large digital LCD display clearly indicates the ambient O2 concentration.
3. Relay outputs to control ventilation devices.
4. Audible and visual alarm indications at three separate alarm levels. Ability to add strobes for additional indication.
5. Automatic barometric pressure compensation for high altitude use.

2. Package Contents & Description

The RAD-0002 package comprises the following parts:
 SEU (Main Sensor Unit), RDU (Remote Display Unit), Power Supply (Pre-Wired), CAT 5 Communication Cable (1 piece), Relay Cables (3 pieces), Wall Plug Safety Strap (1 piece), Warning Signs, User Manual (1 piece) Mounting Brackets (2 pieces), Screws (13 pieces), Wall Anchors (12 pieces) Cable Clips (10 pieces), International Power Adaptor (3 pieces)

SEU (Main Sensor Unit)

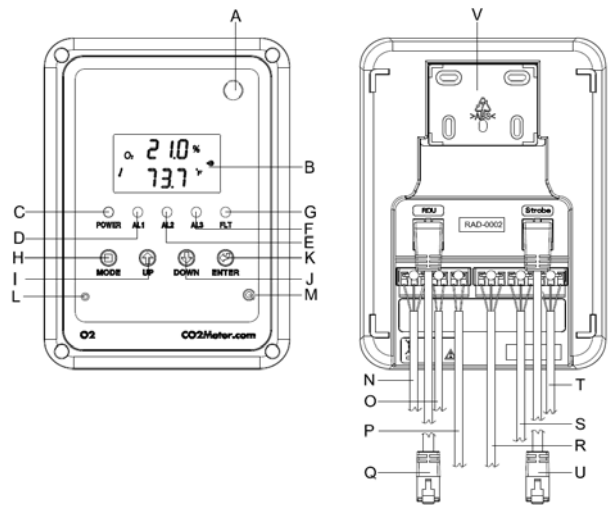

- A. O2 Sensor
- B. LCD display
- C. Power Green LED
- D. Alarm 1 Red LED
- E. Alarm 2 Red LED
- F. Alarm 3 Red LED
- G. Fault Yellow LED
- H. MODE Button
- I. UP Button
- J. DOWN Button
- K. ENTER Button
- L. Alarm Buzzer
- M. Reset Button
- N. 4-20mA Output
- O. Battery Backup Input
- P. DC Power Supply
- Q. RDU Cable (RJ45)
- R. Relay 3 for AL3
- S. Relay 2 for AL2
- T. Relay 1 for AL1
- U. Strobe Cable (RJ45)
- V. Mount/Panel Holder

RDU (Remote Display Unit)

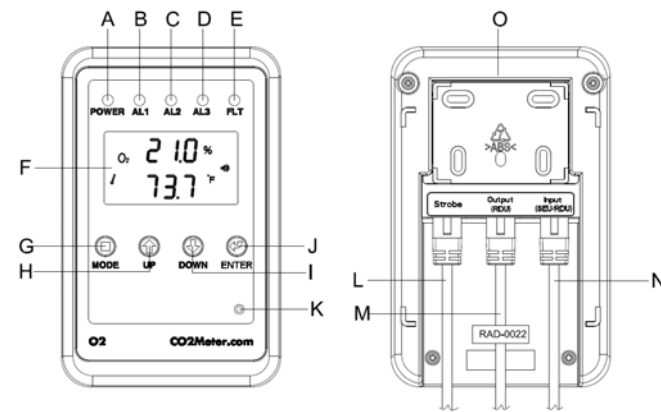

- A. Power Green LED
- B. Alarm 1 Red LED
- C. Alarm 2 Red LED
- D. Alarm 3 Red LED
- E. Fault Yellow LED
- F. LCD display
- G. MODE Button
- H. UP Button
- I. DOWN Button
- J. ENTER Button
- K. Alarm Buzzer
- L. Strobe Cable (RJ45)
- M. Output Cable to RDU (RJ45)
- N. Input Cable from SEU/RDU (RJ45)
- O. Panel Holder

3. LCD Display Symbol

Symbol	Meaning	Description
	O2 Concentration ppm (Parts Per Million)	Ambient O2 Concentration
	Alarm	Alarm Icon
DIAG	Diagnostics	Test communications between the SEU and RDU (see 10.3)
AL1	1st O2 Alarm Level	Alarm 1 will trigger when O2 concentration is below the first alarm level (default 19.0%). AL1 (Red LED 1) and Fault LED will flash, buzzer will sound, and Relay 1 will activate. If there is strobe, the strobe will flash. This status will remain latched. (see 9.1)
AL2	2nd O2 Alarm Level	Alarm 2 will trigger when O2 concentration is below the second alarm level (default 17.0%). AL1, AL2, Fault LED will flash, buzzer will sound and relay1 and relay2 will activate. If there is strobe, the strobe will flash. This status will remain latched. (see 9.1)
AL3	3rd O2 Alarm Level	Alarm 3 will trigger when O2 concentration is below the third alarm level (default 15.0%). AL1, AL2, AL3, Fault LED will flash, buzzer will sound and relay1, relay2, relay3 will activate. If there is strobe, the strobe will flash. This status will remain latched. (see 9.1)
CALI	Calibration Icon	Displays when calibrating the O2 sensor to adjust for long-term drift from the actual O2 concentration. (see 10.7)
RCFS	Recover Factory Settings	Reset To factory default settings, removes all custom settings.
Hi	High	The O2 concentration is above 25%
	Fan Icon	The fan will appear when alarm levels are reached. Any device connected to the relays will run.

4. SEU (Main Sensor Unit)

The SEU (Main Sensor Unit) houses the oxygen sensor, connections to the 3 alarm relays, a strobe (if used) and the connection to the RDU(s). Power for both the SEU and RDU are supplied by the SEU. All setup functions and calibration are performed from the SEU.

The SEU should be placed in a room where inert gases like Nitrogen, Argon, and others are stored and oxygen depletion can occur. The large LCD displays the ambient O2 concentration in real-time.

There are three separate O2 alarm levels: AL1, AL2 and AL3. All are preset to OSHA standards but may be customized (see Section 10).

When the RAD-0002 Monitor detects an oxygen value below AL1, the Alarm 1 Red LED and Yellow Fault LED will blink, Relay 1 will activate, an audible alarm will sound, and the Strobe will activate if present. The alarm will continue until the RESET button on the SEU is pressed unless the Latch Function is turned off (see Section 9.2).

If the oxygen level continues to decrease below AL2, the Alarm 1 Red LED, the Alarm 2 Red LED, and Fault Yellow LED will blink, Relay 1 and Relay 2 will activate and the audible alarm will sound, The Strobe will activate if present. The alarm will continue until the RESET button on the SEU is pressed unless the Latch Function is turned off (see Section 9.2).

If the oxygen level continues to decrease below AL3, all 3 Alarm Red LEDs will blink, all 3 relays will activate and the audible alarm will sound. The alarm will continue until the RESET button on the SEU is pressed unless the Latch Function is turned off (see Section 9.2).

5. RDU (Remote Display Unit)

The RDU should be placed outside the enclosed area (typically next to a door) to warn users if the oxygen level inside the enclosed area have changed. The RDU is controlled and powered by the SEU. A strobe may be attached to the RDU.

All visual and buzzer alarms on the SEU are duplicated on the RD. The SEU only has the "DIAG" function to test the communication between the SEU and RDU (see 10.3). All other functions or settings must be changed on the SEU.

6. Strobes

Strobes are add-on visible alarms. One strobe can be connected to the RDU and one to the SEU. If the oxygen level goes below Alarm Level1, the strobes will flash. The frequency of the flash cannot be changed.

7. Power

The RAD-0002 comes pre-wired with a 12V power supply that plugs in to a 120-240VAC wall outlet. The 12V power supply can be removed and 24VDC can be wired directly to the SEU through the terminal block. 24VAC must be converted to 24VDC for the monitor to operate.

8. Installation

1. Choose a suitable location near a wall outlet to install the SEU. Fix the panel holder on the wall with the four screws provided.
2. Put the SEU on the panel holder, making sure that they are connected tightly.
3. Fix the second panel holder in a suitable location outside the monitored space at eye level. Place the RDU onto the panel holder. Display warning signs next to the RDU so they are not hidden when the door is open.
4. Route the included CAT5 cable between the SEU and RDU. CAT5 cable can be run through the wall/conduit or fixed to the wall using cable clips. Plug the CAT5 cable into the designated ports on both units. 2 additional RDUs can be connected to the first RDU as long as the total cable length between the farthest RDU and SEU is less than 300ft. (91m).
5. The RAD-0002 has 3 relay outputs connected to the programmed alarm settings. All relays are normally open/closed dry contacts. Any of the relays can be used to control an external device (fan, HVAC system, etc.) or can be wired to the fire alarm panel directly. The relays will trigger when the CO2 concentration exceeds the programmed alarm level.
6. When the power has been connected, The SEU and the RDU will perform a self-check, then begin to work. If the cable between the SEU & RDU is not securely connected, the yellow fault LED on the SEU will blink after startup. If cable is inserted into the wrong port on RDU, after about one minute, "Er7" will flash on the RDU display. Securely plug the cable into the correct port on RDU for the unit to function normally.

7. To test the system, use the DIAG function. The five LED's will blink and the buzzer will sound on both the SEU and RDU. Then both LCD screens will show the same information. This verifies that alarm is ready.

Installation Example:

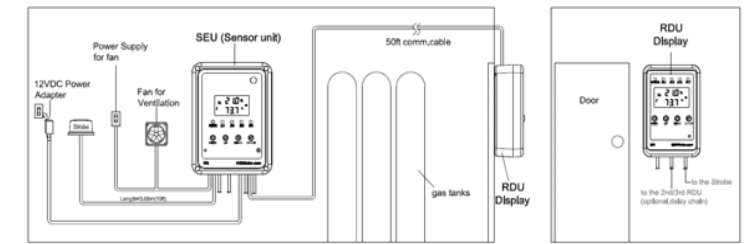

9. Advanced Management Settings

These settings use a non-obvious key combination to prevent casual users from changing alarm settings. In most cases, the default settings are recommended.

9.1 Alarm Level Lock / Unlock: If the alarms are locked, an employee cannot change the alarm levels. Factory default is locked. You must unlock the alarm levels before you can change them (see Section 10).

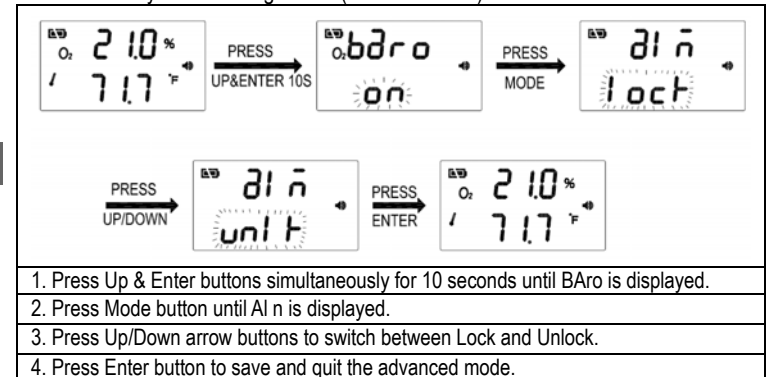

9.2 Latch Function On / Off: If the Latch function is on, alarms will continue until the reset button is pressed even if the O2 level returns to normal. Factory default is on.

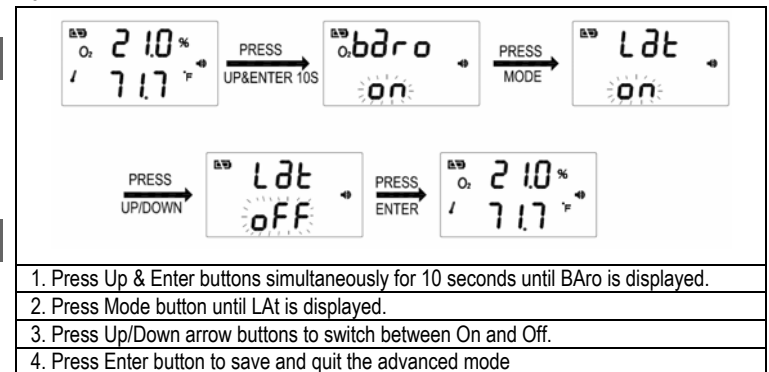

9.3 Barometric Compensation On / Off: Turns on automatic compensation for barometric pressure / altitude. Factory default is on.

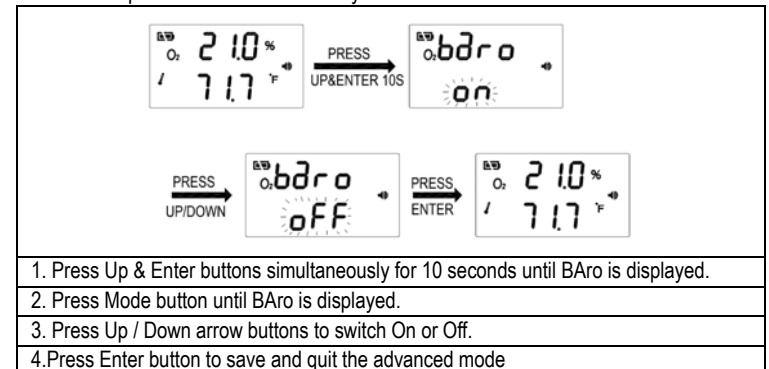

10. Customizing the Settings

10.1 Select Temperature Units: Press the Up button to switch between °F & °C.



10.2 Select Barometric Units: Press the Down button to switch from hPa to inHg

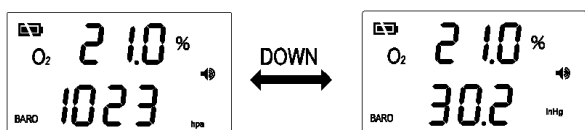

10.3 Diagnostic Test: Test the communication link between the SEU & RDU.



1. Press Mode until the "DIAG" icon flashes
2. Press Enter. The five LED's will blink and the buzzer will sound on the SEU and RDU simultaneously.

10.4 Set AL1 Alarm Level: (only if Alarm level is unlocked - see 9.1)



1. Press Mode until the "O2" & "AL1" icons flash
2. Press Enter, the "AL1" icon shows on LCD. Default AL1 = 19.0%
3. Press Up/Down to go through AL1 levels: 18.0%, 18.5%, 19.0%, 19.5%, 20.0%
4. Press Enter to save or press Mode to exit without saving.

10.5 Set AL2 Alarm Level: (only if Alarm level is unlocked - see 9.1)

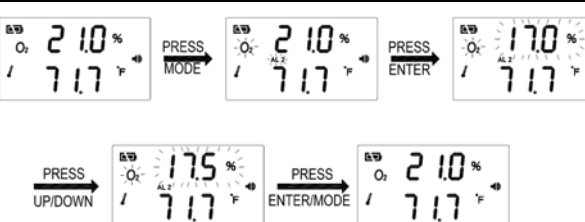

1. Press Mode until the "O2" "AL2" icon flashes
2. Press Enter, the "AL2" icon shows on LCD. Default AL2 = 17.0%
3. Press Up/Down to go through AL2 levels: 16.0%, 16.5%, 17.0%, 17.5%
4. Press Enter to save or press Mode to exit without saving.

10.6 Set AL3 Alarm Level: (only if alarm level is unlocked - see 9.1)

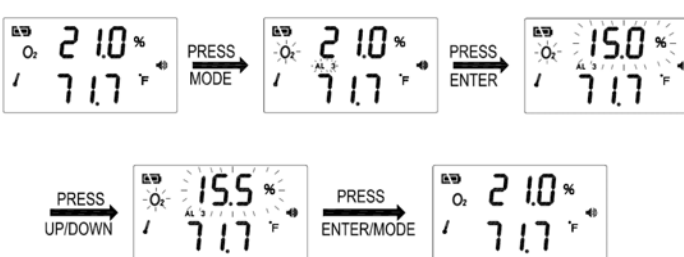

1. Press Mode until the "O2" "AL3" icon flashes
2. Press Enter, the "AL3" icon shows on LCD. Default AL3 = 15.0%
3. Press Up/Down to go through AL3 levels: 13.0%, 13.5%, 14.0%, 14.5%, 15.0%, 15.5%
4. Press Enter to save or press Mode to exit without saving.

Note: The 3 alarm levels cannot overlap.

10.7 Calibration:

Zero and Span Calibration should both be performed at least annually. They can be performed onsite or the SEU can be returned for factory calibration. Check your state or local code for calibration schedule requirements in your jurisdiction.

What you will need: a test gas cylinder of pure nitrogen (0% O2), a cylinder of 21% oxygen, a regulator, tubing, and a small piece of masking tape to cover the buzzer hole on the bottom right corner of the SEU. If you are calibrating in situ, first inform occupants to ignore the alarms while calibration takes place.

Part 1: Zero Calibration:

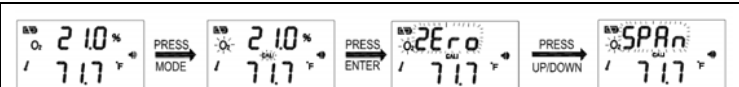

1. Hold the tubing from the Nitrogen (0% O2) gas cylinder to the oxygen sensor opening on the top right-hand corner of the SEU.
2. Open the gas regulator. Set the flow rate between 0.15-0.50 liters per minute.
3. Wait until the O2 reading on the SEU settles consistently at or near 0% O2 on the screen. All alarms will be triggered.
4. Press the Mode button 5 times. The "O2" and "CAL" icons will flash.
5. Press Enter to view the calibration settings. The words "O2" and "ZERO" will begin flashing on the LCD.
6. Press Enter again to begin calibrating. "CALIBRATING" will begin flashing.
7. After approximately 3 minutes, the LCD will display either "PASS" or "FAIL"
8. If the LCD reads "FAIL", repeat the steps again. If it displays "PASS", press Enter. The display should now show 0%
9. Remove the nitrogen gas.
10. Press the Reset button at the bottom right-hand side of the SEU front cover.

Part 2: Span Calibration:

1. Hold the tubing from the 21% oxygen gas cylinder to the oxygen sensor opening on the top right-hand corner of the SEU.
2. Open the gas regulator. Set the flow rate between 0.15-0.50 liters per minute.
3. Wait until the O2 reading on the SEU settles consistently at or near 21% O2 on the screen.
4. Press the Mode button 5 times. The "O2" and "CAL" icons will flash.
5. Press Enter to view the calibration settings. The words "O2" and "ZERO" will begin flashing on the LCD.
6. Press the Up or Down arrow key to change from "Zero" to "SPAN".
7. Press Enter again to begin calibrating. "CALIBRATING" will begin flashing.
8. After approximately 3 minutes, the LCD will display either "PASS" or "FAIL"
9. If the LCD reads "FAIL", repeat the steps again. If it displays "PASS", press Enter. The display should now show 21% O2.
10. Remove the oxygen gas.
11. Press the Reset button at the bottom right-hand side of the SEU front cover.
12. Remove tape over the alarm buzzer holes.

10.8 Recover Factory Settings:

If calibration or changing custom parameters has caused the RAD-0002 to behave incorrectly, use the ReFactSet (Recover Factory Settings) function to return the unit to its original condition at shipping.

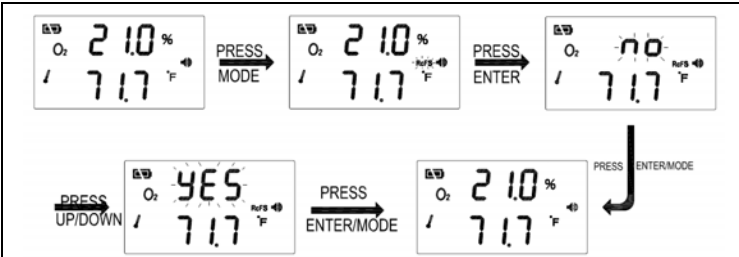

1. Press Mode until the "ReFactSet" icon flashes.
2. Press Up/Down button to choose either "Yes" or "No".
3. Press Enter to save or press Mode to exit without saving.

11. Product Care

To insure you receive the maximum benefit from using this product, please observe the follow guidelines.

1. Repair - Do not attempt to repair the product or modify the circuitry by yourself. Please contact CO2Meter directly if the product needs servicing, including the replacement or calibration of sensor See section 15 for technical support contact information.
2. Cleaning - Disconnect the power before cleaning. Use a damp cloth. Do not use liquid cleaning agents such as benzene, thinner or aerosols, as these will damage the device.
3. Maintenance - We recommend testing the communication between the SEU and RDU under 'DIAG' function. If these five LEDs blink and the buzzer of SEU and RDU sound simultaneously, it indicates that SEU and RDU work normally.

12. Specifications

■ Oxygen & Temperature Sensor Specifications:

Oxygen Sensor Specifications	
Measurement Range	0 - 25% display
Display Resolution	0.1%
Accuracy	Better than 2%FS
Pressure Dependence	Auto pressure compensation, built in barometer. (500/1200 mbar)
Response Time	O2: <2min by 90%
O2 AL1	18.0%, 18.5%, 19.0%, 19.5%, 20.0%. The default AL1 is 19.0%.
O2 AL2	16.0%, 16.5%, 17.0%, 17.5%. The default AL2 is 17.0%
O2 AL3	15.5%, 15.0%, 14.5%, 14.0%, 13.5%, 13.0%. The default AL3 is 15.0%.
Sound Alarm	80db@10cm
Warm-Up Time	< 60 seconds at 72°F (22°C)
Temperature Sensor Specifications:	
Temperature Range	32°F to 122°F (0°C to 50°C)
Display Resolution	0.1°F (0.1°C)
Display Options	°F / °C
Accuracy	±2.7°F (±1.5°C) when O2 concentration is below first alarm level
Response Time	20-30 minutes (case must equalize with environment)
Operating Conditions:	
Operating Temperature	32°F to 122°F (0°C to 50°C)
Humidity Range	0 ~ 95% RH non-condensing
Storage Conditions:	
Storage Temperature	-4°F to 140°F (-20°C to 60 °C)

■ Power Supply

Power Supply	DC	9~32VDC (12~32VDC recommended), 2A.
	AC adapter	Input: 100~240 VAC,50/60Hz, 0.6A Output: 12VDC, 2000mA.
Battery	Voltage	6VDC (5.4V~7.0V), recommended capacity is 12AH

■ Relay Outputs

Relays 1-3	Peak current for each relay < 2A @ 30VDC or 250VAC Relay configuration: SPDT
------------	---

■ 4-20mA Outputs

CL01:4-20mA	O2: 0~25%
CL02:4-20mA	Temp: 32 to 122°F (0-50°C)

■ Weight and Dimensions

SEU	Weight	1 lb.
	Dimensions (LxWxD)	6.69 x 4.96 x 2.73 inches
RDU	Weight	0.4 lb.
	Dimensions (LxWxD)	5.51 x 3.54 x 1.89 inches

13. Safety Notes

Warning: Your safety is very important to us. To ensure to use the product correctly and safety, please read these warnings and the entire User Manual before using the product. Otherwise, the protection provided by the equipment may be impaired. These warnings provide important safety information and should be observed at all times.

1. Please handle the device carefully; do not subject the product to impact or shock. Otherwise, this may cause the accuracy drift.
2. Do not place the unit near a heat source. Heat can cause distortion of the unit, which may result in an explosion or fire.
3. Do not touch the exposed electronic circuitry of the device under any circumstances, as there is the dangerous of electric shocks.
4. Please take care of cable connection between SEU and RDU. Make sure the cable from SEU is connected into the INPUT port of RDU.
5. Please ensure the external power supply is normally supplied to ventilation fan while the relay is working. If there has no normally power supply to the fan, the relay will not work, which may result in potential danger with lower O2 concentration in confined space.

14. Fault Codes & Troubleshooting Guide

This section includes a list of Frequently Asked Questions for problems you may encounter with the RAD-0002 O2 Monitor.

No	LCD Fault Icon	Description (of the fault)	SEU Indication	RDU Indication	Suggested Actions
1	Er3	The ambient temperature has exceeded the temperature range 32°F to 122°F (0°C to 50°C)	"Er3" flash, Fault LED blink	"Er3" flash, Fault LED blink	This error will disappear when the temperature returns to the range between 32°F to 122°F (0°C and 50°C)
2	Er5	EEPROM System Problem	"Er5" flash, Fault LED blink	"Er5" flash, Fault LED blink	Power on again or press reset button, if the "Er5" always appear, please contact with the local dealer.
3	Er7	Internal Data Transmission Error	"Er7" flash, Fault LED blink,	"Er7" flash, Fault LED Blink	Check the RJ45 plug is connected into the INPUT port of RDU, if the "Er7" displays on the RDU only. Press reset button on SEU or power on again

15. Support & Warranty

Contact us: We're here to help!

If the troubleshooting guide above doesn't help you solving your problem or for more information, please contact us using the information below.

Support@CO2Meter.com
(386) 256-4910 (M-F 9:00am-5:00pm EST)
www.CO2Meter.com

See CO2Meter, Inc. Terms & Conditions at,
www.CO2Meter.com/pages/terms-conditions

CO2Meter, Inc.
131 Business Center Drive
Ormond Beach, FL 32174
Phone: 386-872-7665 | Fax: 866-422-2356
Email: Sales@CO2Meter.com