

GSS Sensor User's Manual



COZIR™, SprintIR™, MISIR™ and MinIR™ Sensors

Table of Contents

1	Guidelines for All Sensors	5
1.1	Power Supply	5
1.2	Calibration Procedure	5
1.3	Ambient Sensors	5
1.4	Wide-Range Sensors	5
1.5	Physical Configuration	5
1.6	Dynamic Power Requirements	6
2	Serial Format and Connection	7
2.1	Connection	7
2.2	Serial Connection	8
2.3	Reading Format	8
2.3.1	CO ₂ Measurement	8
2.3.2	Temperature Measurement (Optional)	9
2.3.3	Humidity Measurement (Option)	10
2.3.4	Example of T,H and CO ₂	10
3	Command Summary	11
4	Operating Modes	13
4.1	Mode 0 Command Mode	13
4.2	Mode 1 Streaming Mode	13
4.3	Mode 2 Polling Mode	13
5	Output Fields	14
6	Zero Point Calibration	15
6.1	Zero in a Known Gas Concentration (recommended)	15
6.2	Zero in Nitrogen	15
6.3	Zero in Fresh Air (assumed to be 400ppm)	15
6.4	Fine Tune the Zero Point	16
6.5	Zero Point Adjustment	16
7	AutoCalibration	16
7.1	Principle of Operation	16
7.2	Requirements for Auto-calibration	17
7.3	Setting the Auto Calibration Parameters	17
7.4	Autocalibration Intervals	18
7.5	Read the Autocalibration Settings	19
7.6	Disable Autocalibration	19
7.7	Background Concentration	19
8	Altitude Compensation	20
9	User Settings	22
9.1	Digital Filter	22
9.1.1	Customizing the Sensor Response	22
9.1.2	Setting the Digital Filter	23
9.1.3	Reading the Digital Filter Setting	23
9.2	User Options – EEPROM Settings	23
9.2.1	Setting EEPROM	24

9.2.2	Reading EEPROM	24
9.2.3	EEPROM Settings.....	24
9.2.4	Autocalibration Settings (locations 3-7).....	25
9.2.5	User EEPROM	25
10	Command Reference	26
10.1	Customization	26
10.2	Information	27
10.3	Switching between Modes.....	28
10.4	Zeroing and Calibration.....	28
10.5	Polling Commands	30
11	Appendix A: Power Consumption	32
11.1	Operating Modes – Power Levels	33
11.2	Streaming Mode (K 1)	33
11.3	Polling Mode (K 2).....	33
11.4	Command Mode (K 0)	33
11.5	Current Profile.....	34
11.6	Warm-up Time	35
11.7	Minimizing the Power in Streaming and Polling Modes.....	37
11.8	Polling and Streaming Key Points	37
11.9	Minimizing Power using Command Mode.....	38
11.10	Command Mode Power Reduction Key Points	39
11.11	Minimizing Power by Power Cycling	40
11.12	Power Cycling Key Points	41
11.13	Implementing a User Auto-Calibration Routine	42
12	Appendix B: Analog Voltage Output	43
12.1	Ordering Information	43
12.2	Voltage Output Connections.....	44
12.3	Load Impedance.....	44
12.4	Converting Voltage to Concentration	44
12.5	Linearity of the Voltage Output	45
12.6	Noise on the Voltage Output	46
12.7	Changing the Full Scale Concentration	46
12.8	Digital outputs.....	47
12.9	Zero Point Calibration	47
13	Appendix C: Setting the Auto-Calibration Parameters for Older Firmware	48
13.1	Environmental Requirements for Auto-calibration	48
13.2	Auto-calibration using GasLab®	48
13.3	Setting the Auto Calibration Parameters.....	48
13.4	Background Concentration	49
13.5	Auto-calibration Interval.....	49
13.6	Initial Auto-calibration period.....	50
13.7	Auto-Calibration Examples.....	51

This documentation is provided on an as-is basis and no warranty as to its suitability or accuracy for any particular purpose is either made or implied. Neither CO2Meter, Inc. nor Gas Sensing Solutions Ltd will accept any claim for damages howsoever arising as a result of use or failure of this information. Your statutory rights are not affected. This information is not intended for use in any medical appliance, device or system in which the failure of the product might reasonably be expected to result in personal injury. This document provides preliminary information that may be subject to change without notice.

This guide applies to software versions from July 2013. For previous versions, please refer to 'COZIR Software USER's Guide Rev F'

Conventions

In this guide:

`\r\n`

Is used to indicate carriage return <CR> , line feed <LF> characters, (0x0d,0x0a) which are required at the end of each string sent to the sensor, and are appended to all transmissions from the sensor.

-A denotes an ambient model sensor. -W denotes a wide-range sensor.

`Z 12345\r\n`

Courier fixed pitch font is used to show commands sent to the sensor, and transmissions received from the sensor.

RoHS Certification

GSS Ltd. hereby certifies that the COZIR, SprintIR and MISIR products are RoHS compliant and fulfils the definitions and restrictions defined under Directive 2011/65/EU of The European Parliament and of the Council of June 8, 2011 on the restriction of the use of certain hazardous substances in electrical and electronic equipment (EEE).

RFI & CE Certification

The COZIR family of sensors has been used in client and GSS products which have successfully passed through full CE certification. This includes radiated noise immunity as per EN61000-4-3: 2006 Type 1

- 80 – 1000MHz, 3V/m, 80%, 1kHz AM
- 1400 – 2000, 3V/m, 80%, 1kHz AM
- 2000 – 2700MHz, 1V/m, 80%, 1kHz AM

To minimise issues with noise immunity we recommend the following:

- Add a decoupling capacitor across the supply close to the sensor.
- If you are using a switched mode supply, use shielded inductors, and locate away from the sensor. This also applies to other magnetic components such as electromagnetic buzzers.
- Always adhere to the respective manufacturer's advice on PCB layout for switched mode power supply devices.
- Avoid routing power tracks or leads across the sensor.

1 Guidelines for All Sensors

To achieve maximum precision when integrating the GSS line of sensors into a product, we recommend following these guidelines. We have developed these requirements after rigorous testing to maximize the performance and accuracy of the sensor in the host application.

1.1 Power Supply

The sensors **must** be powered with a linear regulator for maximum precision. Power supplies with high frequency noise, such as switching supply circuits, can cause increased noise in the sensor's measured value.

Altering the power supply will require recalibration. We recommend calibrating the sensor in its final installation, calibrating the sensor outside with a different configuration will yield inconsistent calibration results.

1.2 Calibration Procedure

We recommend calibrating all sensors. The procedure differs between models. Calibration gas is available from CO2Meter directly.

1.3 Ambient Sensors

For ambient sensors we recommend an atmospheric calibration. Fresh air is generally assumed to be at 450ppm, but alternatively you can use 450ppm calibration gas.

This reading can be confirmed with 2,000ppm calibration gas to check the span of the sensor, although this step is unnecessary.

1.4 Wide-Range Sensors

For wide-range sensors, we recommend a zero calibration using an end-of-range 95% gas.

This reading can be confirmed with other high-concentration CO2 calibration gases, such as 50% and 25%, although this step is unnecessary.

1.5 Physical Configuration

The sensor can be configured with optional tube caps, available through our website, or simply in an atmospheric sampling configuration. The configuration must be kept consistent between calibration and installation. Calibrating with a different setup will result in inaccurate readings when installed.

When using a sensor without a tube cap, we recommend ensuring turbulence is present across the sensor membrane. This can be achieved with a calibration chamber featuring a recirculation fan or constant flow from a fixed-flow regulator.

1.6 Dynamic Power Requirements

Bench-tested results for ultra-low power sensors powered via USB

Dynamic power requirements become important when operating from a USB port where the supply current might be being shared over several ports (we recommend using powered USB hubs to avoid these potential power issues) or when planning for low power applications like solar power.

When the power is applied to the sensor, initially a higher than normal operating current demand will occur. This inrush current and period will relate to the impedance of the power supply and device switching power.

The measurements below were taken whilst connected to a USB port via a USB to UART bridge cable, 3.3 volts, streaming / polled mode, and same interval of measurement on a COZIR sensor.

- Quiescent: 300 μ A
- Measurement interval: 500 mS
- Measurement period: 20ms
- Measurement current: 30 mA
- RMS operating power: 2 μ W
- Startup inrush current 50 mS @ 60 mA peaks

2 Serial Format and Connection

2.1 Connection

Communication to and from the various sensors is via a serial connection. Pins are shown looking at the connector of the sensor.

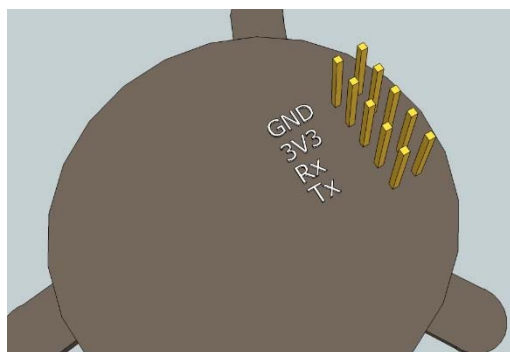

COZIR-Ambient

GND	N/C
3.3V	N/C
Rx	N/C
Tx	Zero
N/C	Ambient

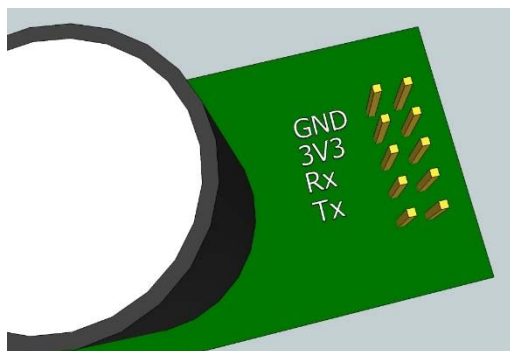

COZIR-Wide Range, SprintIR

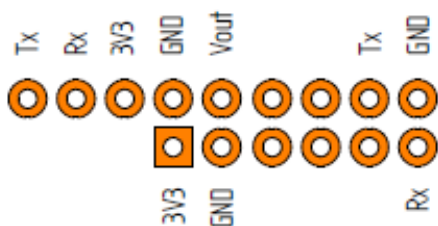

MISIR

Only one GND connection is required.

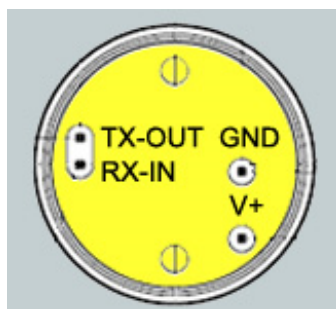

MinIR

GND	0v
V+	3.3-5.5V (3.3V recommended)
Tx-OUT	Voh will be 3V Sensor output
Rx-IN	Used for configuration, etc.

2.2 Serial Connection

The Rx and Tx pins are normally high, suitable for direct connection to a UART. If the sensor is to be read by a true RS232 device (eg a PC) it is necessary to pass through a level converter to step up/down the voltage and invert the signal.

Connection to the sensor is via a 10 way, 0.1" pitch connector. In practice, only the first 4 pins are required (GND, 3V3, Rx and Tx) so a 4 way connector can be used.

A Development kit and free GasLab® software is available to allow USB interfacing between COZIR™ and SprintIR™ sensors and a PC. Contact CO2Meter.com for details.

Parameter	Value
Baud Rate	9600
Data Bits	8
Parity	None
Stop Bits	1
Format	UART (normally high)
Hardware Flow Control	None
Voltage Voh	3V (MISIR $V_{oh} = V_{supply}$)
Voltage Vih	3V-5V

Note: If you connect to the sensor using HyperTerminal®, you must select the box “Send line ends with line feeds” under ASCII setup.

When initially powered, the sensor will immediately start to transmit readings (see Mode 1 in “*Operating Modes*”)

2.3 Reading Format

2.3.1 CO₂ Measurement

The CO₂ measurement is reported as:

`Z ##### z #####\r\n`

where

`Z #####` shows the CO₂ concentration after digitally filtering

and

`z #####` shows the instantaneous CO₂ concentration without any digital filtering.

The concentration is reported in the following units

Type	Range	Units	Example
COZIR-A MISIR	Up to 2%	ppm	Z 00631 = 631ppm
COZIR-W SprintIR-W MinIR-5	Up to 65%	ppm/10	Z 01200 = 12000ppm = 1.2%
COZIR-W-100 SprintIR-W-100 MinIR-100	Up to 100%	ppm/100	Z 01500 = 150000ppm = 15%

Note that the same units must be used when sending concentration information to the sensor (for example, the X command and the F command). If in doubt, the ‘.’ Command (see below) will indicate what multiplier should be applied to the Z output to convert to ppm.

Z 00842 z 00765	Sample output from a sensor with factory settings.
Z 00842 z 00738	
Z 00842 z 00875	This is a COZIR-A, so the reported CO ₂ reading is 842ppm.
Z 00842 z 00858	
Z 00842 z 00817	The second figure shows the instantaneous (unfiltered) CO ₂ reading. See “Digital Filter” for more details.
Z 00842 z 00839	
Z 00842 z 00817	
Z 00842 z 00828	
Z 00842 z 00850	
Z 00842 z 00875	
Z 00842 z 00804	

Note that all output from the sensor has a leading space.

2.3.2 Temperature Measurement (Optional)

The temperature measurement is reported as:

```
T #####\r\n
```

where ##### is a five digit number.

To convert to °C, subtract 1000 and divide by 10.

For example:

```
T 01235\r\n
```

Represents 23.5°C

NB The temperature and humidity sensor is a factory fit option. If it is not fitted, the sensor will return “T 01000”.

2.3.3 Humidity Measurement (Option)

The humidity measurement is reported as:

```
H #####\r\n
```

Where ##### is a five digit number.

To convert to relative humidity (%), divide by 10.

For example:

```
H 00551\r\n
```

Represents 55.1% RH

NB The temperature and humidity sensor is a factory fit option. If it is not fitted, the sensor will return "H 00000".

2.3.4 Example of T,H and CO₂

When shipped, the sensor default output is CO₂ only. To output temperature, humidity and CO₂, send "M 4164\r\n" (see "**Output Fields**"). The output format will have the form:

```
H 00345 T 01195 Z 00651\r\n
```

This example indicates 34.5% RH, 19.5°C and 651ppm CO₂

3 Command Summary

For complete details of the commands and their correct usage, please refer to the “**Command Reference**”.

IMPORTANT:

- All commands **must be terminated with a carriage return and line feed <CR><LF>**. In this document, this is shown as ‘\r\n’.
- Commands which take a parameter **always** have a space between the letter and the parameter.
- The sensor will respond with a ‘?’ if a command is not recognized. The two most common causes are missing spaces or missing <CR><LF> terminators.

Command	Use	Example	Response	Comments
A ###\r\n	Set the digital Filter	A 16\r\n	A 00016\r\n	See “ <i>User Settings</i> ”
a\r\n	Return the digital filter setting	a\r\n	a 00016\r\n	See “ <i>User Settings</i> ”
F #####\r\n	Fine Tune the zero point	F 410 400\r\n	F 33000\r\n	See “ <i>Zero Point Calibration</i> ”
G\r\n	Zero point calibration using fresh air.	G\r\n	G 33000\r\n	See “ <i>Zero Point Calibration</i> ”
H\r\n	Return most recent humidity measurement	H\r\n	H 00552\r\n	=55.2% in the example. Humidity sensing is a factory fit option.
K #\r\n	Selects the operating mode	K 1\r\n	K 00001\r\n	See “ <i>Operating Modes</i> ”
M #####\r\n	Sets the output fields	M 6\r\n	M 00006\r\n	See “ <i>Output Fields</i> ”
P ###\r\n	Sets a user configurable field in EEPROM	P 1 10\r\n	P 00001 00010\r\n	See “ <i>User Settings</i> ”
p ###\r\n	Reads a user-configurable field from EEPROM	p 10\r\n	p 00010 00001\r\n	See “ <i>User Settings</i> ”
Q\r\n	Return most recent fields	Q\r\n		See “ <i>Command Reference</i> ”
S #####\r\n	Sets the span calibration value	S 8192\r\n	S 08192\r\n	See “ <i>Span Calibration</i> ”
s\r\n	Return the span calibration value	s\r\n	s 08192\r\n	See “ <i>Span Calibration</i> ”
T\r\n	Return the most recent temperature measurement	T\r\n	T 01225\r\n	22.5°C in the example. Temperature sensing is a factory fit option.
U\r\n	Zero point calibration using nitrogen.	U\r\n	U 33000\r\n	See “ <i>Zero Point Calibration</i> ”
u #####\r\n	Manual setting of the zero point.	u 32997\r\n	u 32997\r\n	See “ <i>Zero Point Calibration</i> ”
X #####\r\n	Zero point setting using a known gas calibration	X 2000\r\n	X 32997\r\n	See “ <i>Zero Point Calibration</i> ”

Command	Use	Example	Response	Comments
Y\r\n	Return firmware version and sensor serial number	Y\r\n	Returns <u>two</u> lines	See " Command Reference " for details
Z\r\n	Return the most recent CO2 measurement.	Z\r\n	Z 01521\r\n	1521ppm in the example
@ #.#.#.#\r\n	Autocalibration configuration	@ 1.0 8.0\r\n	@ 1.0 8.0\r\n	See " Autocalibration " for details
.\r\n	Return the multiplier required to convert the Z output to ppm	.\r\n	.00100\r\n	Multiply by 100 in the example
*\r\n	Return configuration information.	*\r\n		See the " Command Reference " for details

All communications are in ASCII and are terminated by carriage return, line feed (ASCII characters 13 and 10). This document uses the protocol "\r\n" to indicate the carriage return line feed.

All responses from the sensor, including measurements, have a leading space (ASCII character 32).

The character '#' represents an ASCII representation of a numeric character (0-9).

Note that there is a space between the first letter and any parameter. For example, the X command reads "X space 2000 carriage return line feed".

Note that all settings are stored in non-volatile memory, so the sensor only has to be configured once. It should not be configured every time it is powered up.

4 Operating Modes

The COZIR™, SprintIR™, MISIR™ and MinIR™ sensors can be operated in three different modes. Users can switch between the modes using the “K” command.

4.1 Mode 0 Command Mode

This is primarily intended for use when extracting larger chunks of information from the sensor (for example using the Y and * commands).

In this mode, the sensor is stopped waiting for commands. No measurements are made, and the sensor will run through a warm-up cycle after exiting this command. There is no latency in command responses. The power consumption is less than 3.5mW as no measurement activity takes place. Commands which report measurements or alter the zero point setting are disabled in mode 0.

Mode 0 is NOT retained after power cycling. The sensor will always power up in streaming or polling mode, whichever was the most recently used.

4.2 Mode 1 Streaming Mode

This is the factory default. Measurements are reported twice per second for COZIR, MinIR and MSIR sensors and 20 times per second for SprintIR sensors. Commands are processed when received, except during measurement activity, so there may be a time delay of up to 100mS in responding to commands. The power consumption is 3.5mW (assuming one field of information is transmitted, and there is no temperature and humidity sensor).

4.3 Mode 2 Polling Mode

In polling mode, the sensor only reports readings when requested. The measurement cycle continues in the background, but the output stream is suppressed. The power consumption depends on the frequency of polling, but is approximately the same as the streaming mode power consumption.

Note that the sensor will power up in the mode last used. If it was last used in K0 mode, it will power up in either K1 or K2 mode, depending on which was most recently used.

In Polling Mode, measurements can be accessed using the polling commands H, L, Q, T and Z (see *“Command Reference”*).

5 Output Fields

The COZIR™ sensor can be configured to output up to five fields of information. Typically, the only fields of interest are the CO₂ concentration, Temperature (if fitted) and Humidity (if fitted).

This allows users to customize the output string transmitted by the sensor. Up to five values can be transmitted in the string. The format is always the same: each field is identified by a single character, followed by a space, followed by the five digit number indicating the value of the parameter.

The output fields can be set by sending a command of the format `M 12345\r\n` where 12345 represents a mask value which defines the output fields.

The mask value is created by adding the mask values for the parameters required (see table below).

The sensor will output a maximum of five fields. If the mask setting represents more than five fields, only the first five (those with the highest mask values) will be output.

SprintIR sensors have a limited time to transmit information, so no more than two fields should be selected for output.

Parameter	Field Identifier	Mask Value	Comments
Reserved		32768	Reserved
Reserved		16384	Reserved
Reserved		8192	Reserved
Humidity	H	4096	Reports the humidity output of the Temperature and Humidity Sensor (if Fitted).
D digitally filtered	d	2048	Reports a value related to the normalized LED signal strength (smoothed)
D unfiltered	D	1024	Reports a value related to the normalized LED signal strength
Reserved		512	Reserved
Zero Set Point	h	256	Reports a value related to the normalized LED signal strength
Sensor Temperature (unfiltered)	V	128	Reports a value which varies inversely with the sensor temperature.
Temperature	T	64	Reports the temperature output of the Temperature and Humidity Sensor (if Fitted).
LED Signal (digitally filtered)	o	32	Reports a value which gives an indication of the LED signal strength (smoothed)
LED Signal (unfiltered)	O	16	Reports a value which gives an indication of the LED signal strength.
Sensor Temperature (filtered)	v	8	Reports a value which varies inversely with the sensor temperature. (smoothed)
CO2 Output (Digitally Filtered)	Z	4	Digitally filtered CO2 reading
CO2 Output (not filtered)	z	2	Instantaneous CO2 reading
Reserved		1	Reserved

Note that most fields are for advanced use only and require specific guidance from GSS engineering for their correct interpretation and use. Measurement field are indicated in **bold**.

For example, to output the temperature, humidity and CO2 measurements, send:

```
M 4164\r\n
```

The output string will then be:

```
H 12345 T 12345 Z 00010\r\n
```

6 Zero Point Calibration

There are a several methods to calibrate the zero point of the sensor. The recommended method is zero point calibration in a known gas (see X command) which will give the most accurate zero setting.

In all cases, the best zero is obtained when the gas concentration is stable and the sensor is at a stabilized temperature.

6.1 Zero in a Known Gas Concentration (recommended)

Place the sensor in a known gas concentration and allow time for the sensor temperature to stabilize, and for the gas to be fully diffused into the sensor.

Send the command `X ###\r\n`

The concentration must be in the same units as the sensor output (see **“Reading Format”**). The sensor will respond with an echo of the command and the new zero point.

For example, to set the zero point in a COZIR-A when the sensor is in a known gas concentration of 2000ppm

send: `X 2000\r\n`

response: `X 32950\r\n`

6.2 Zero in Nitrogen

Place the sensor in a gas containing no CO2 (typically nitrogen) and allow time for the sensor temperature to stabilize, and for the gas to be fully diffused into the sensor.

Send the command `U\r\n`

The sensor will respond with an echo of the command and the new zero point.

For example,

send: `U\r\n`

response: `U 32950\r\n`

6.3 Zero in Fresh Air (assumed to be 400ppm)

If there is no calibration gas and no nitrogen available, the sensor zero point can be set in fresh air. The sensor is programmed to assume that fresh air is 400ppm (this value is user configurable – see **“User Settings”**).

Place the sensor in a fresh air environment and allow time for the sensor temperature to stabilize, and for the fresh air to be fully diffused into the sensor.

Send the command `G\r\n`

The sensor will respond with an echo of the command and the new zero point.

For example,

```
send:      G\r\n
response:  G 32950\r\n
```

6.4 Fine Tune the Zero Point

If the CO₂ concentration and the sensor reported concentration are known, the zero point can be adjusted using the known concentration to fine tune the zero point. This is similar in operation to the “X” command (see above) but can operate on historic data. For example, if the sensor has been in an environment in which it is known to have been exposed to outside air, and the sensor reading is known at that time, the zero point can be fine-tuned to correct the reading. This is typically used to implement automated calibration routines.

The command takes two parameters, separated by a space. The first parameter is the reading reported by the sensor. The second is the corrected reading. Both parameters must be in the same units as the sensor output (see “*Reading Format*”)

The sensor will respond with an echo of the command and the new zero point.

For example,

```
send:      F 400 380\r\n
response:  F 32950\r\n
```

In this example, the sensor zero point would be corrected so that a reading of 400ppm, would now be reported as 380ppm.

6.5 Zero Point Adjustment

The precise zero point can be fine-tuned by sending a zero point to the sensor. This is not recommended for general use.

Send the command `u #####\r\n` where ##### is the new zero point.

7 AutoCalibration

7.1 Principle of Operation

COZIR sensors are fully calibrated prior to shipping from the factory. Over time, the zero point of the sensor needs to be calibrated to maintain the long term stability of the sensor.

In many applications, this can happen automatically using the built in auto-calibration function.

This technique can be used in situations in which sensors will be exposed to typical background levels (400-450ppm) at least once during the auto-calibration period. For example, many buildings will drop quickly to background CO₂ levels when unoccupied overnight or at weekends. The auto-calibration function uses the information gathered at these periods to recalibrate.

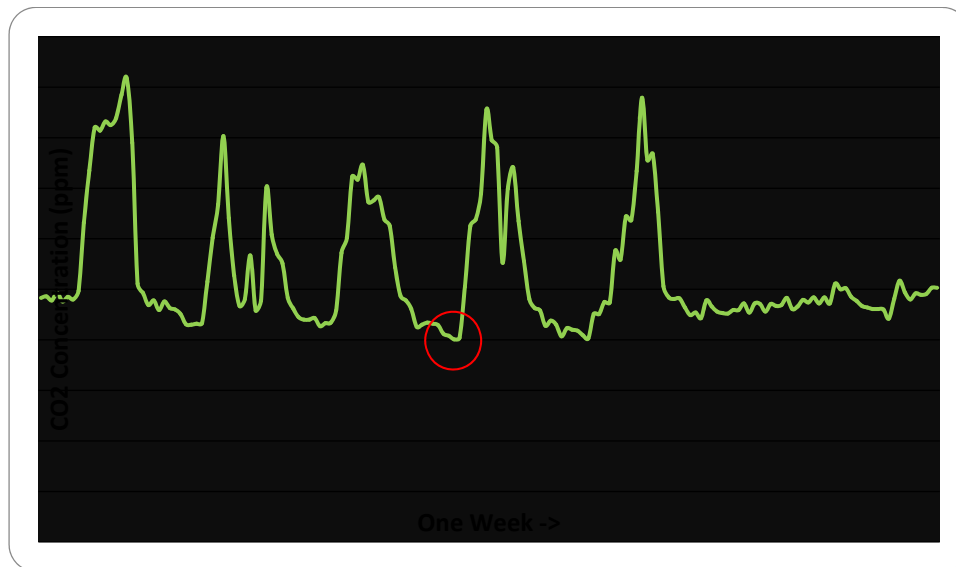

This recording from a sensor shows a typical one week recording in an office environment. The auto-calibration function uses the low point (circled) and uses it to recalibrate the zero point.

7.2 Requirements for Auto-calibration

Exposure to Fresh Air

The sensor must 'see' fresh air at least once during the auto-calibration period. You do not need to know when the fresh air will be sensed, just that it will be sensed at some point during the period.

Continuously Powered

The auto-calibration information is deleted when the sensor is switched off. This ensures that each installation is unaffected by any previous history of the sensor. For auto-calibration to function, it must be power on for the whole of the auto-calibration period.

7.3 Setting the Auto Calibration Parameters

Three parameters are required to enable the auto-calibration routine:

Auto-Calibration Interval

This determines how often the auto-calibration takes place.

Background Concentration

Typically 400-450ppm. This is the level the sensor will use as background.

Initial Auto-calibration Interval

It is possible for the first auto-calibration to take place more quickly than the regular auto-calibration event. This can be useful to stabilize quickly after installation.

Note that the autocalibration timers are reset when the power to the sensor is interrupted. On power on, the sensor will always time an initial autocalibration interval first, then settle into the regular autocalibration cycle.

The regular autocalibration timer is reset automatically if the user calibrates the sensor using the U,G,X,F or u commands.

Before setting the auto-calibration parameters, please note the following:

- Before altering the auto-calibration parameters, switch the sensor into command mode:
send

```
K 0 <CR><LF>
```

This stops the measurement process in the sensor.

- All commands must be terminated with `\r\n` (carriage return, line feed). NB HyperTerminal does not add the line feed character as standard. The ASCII Setup must be configured to append line feeds.

7.4 Autocalibration Intervals

The autocalibration intervals are set using the '@' command. This command allows the autocalibration periods to be set, interrogated or disabled.

To set the autocalibration intervals, the command structure is

```
@ initialinterval regularinterval\r\n
```

Where both the initial interval and regular interval are given in days. Both must be entered with a decimal point and one figure after the decimal point.

For example

```
send:      @ 1.0 8.0\r\nresponse:  @ 1.0 8.0\r\n
```

Will set the autocalibration interval to 8 days, and the initial interval to 1 day.

Note that there is a space between the @ and the first number, and a space between the two numbers. In hex, the example above reads

```
40 20 31 2E 30 20 38 2E 30 0D 0A
```

7.5 Read the Autocalibration Settings

To determine the current autocalibration settings:

```
send:      @ \r\n
response:  @ 1.0 8.0\r\n
```

If the autocalibration is enabled, the sensor will respond with the format above showing the initial and regular autocalibration intervals. If the autocalibration is disabled, the sensor will respond with

```
send:      @ \r\n
response:  @ 0\r\n
```

7.6 Disable Autocalibration

To disable the autocalibration:

```
send:      @ 0\r\n
response:  @ 0\r\n
```

ie, @ followed by a space followed by a zero terminated with 0x0d 0x0a

7.7 Background Concentration

The background concentration depends somewhat on the area the sensor is installed. Typically, a figure between 400ppm and 450ppm is used. The factory default is 400ppm.

To set this, send

```
P 8 x\r\n
P 9 y\r\n
```

where x and y depend on the concentration you want to set.

Concentration	x	Y
380	1	124
400	1	144
425	1	169
450	1	194

This is stored as a two byte value, the high byte being in location 8 and the low byte in location 9. The value represents the concentration.

To calculate other values,

$x = \text{int}(\text{concentration}/256)$

$y = \text{the remainder after dividing concentration}/256$

8 Altitude Compensation

Important

This feature was introduced in sensors manufactured after July 2013 using firmware version AL17 or higher. The firmware version can be identified by sending the Y or * command.

Altitude compensation applies a permanent correction to the sensor response, so should only be used when it is known that the sensor will be operating at altitude permanently.

NDIR gas sensors, such as the COZIR, SprintIR and MISIR family of sensors, detect the concentration of gas by measuring the degree of light absorption by the gas analysis. The degree of light absorption is then converted into a concentration reported by the sensor.

The absorption process is pressure dependent, so that a change in pressure will cause a change in the reported gas concentration. As the pressure increases, the reported gas concentration also increases. As the pressure decreases, the reported concentration decreases.

This effect takes place at a molecular level as is common to all NDIR gas sensors.

In normal use, the reading will vary by 0.1% of reading for each mbar change in barometric pressure (the sensor are calibrated at 1013mbar).

If the sensor is installed at an elevated altitude, the mean barometric pressure will be lower than 1013mbar. It is possible to configure the sensor to correct for this effect, by setting the altitude when installing. This will apply a permanent correction to the output of the sensor, depending on the altitude setting selected.

To apply this correction,

- 1) Select the appropriate code from the table below (intermediate values can be interpolated)
- 2) Send the "`S ####\r\n`" to the sensor, where #### is the code from the table below.

For example, to correct the sensor for permanent installation at 305m elevation,

send: `S 8494\r\n`

response: `S 08494\r\n`

Altitude (ft.)	Altitude (m)	Barometric Pressure (mbar)	Code
-1000	-305	1050	7889
0	0	1013	8192
1000	305	976	8495
2000	610	942	8774
3000	915	908	9052
4000	1219	875	9322
5000	1524	843	9585

The current setting can be determined by sending a lower case s:

send: `s\r\n`

response: `s 08494\r\n`

9 User Settings

9.1 Digital Filter

9.1.1 Customizing the Sensor Response

The CO2 measurement is passed through a digital filter to condition the signal. The characteristics of the filter can be altered by the user to tune the sensor performance to specific applications.

The filter operates as a low pass filter - increasing the filter parameter reduces measurement noise, but slows the response. There is a tradeoff between noise (resolution) and speed of response.

The filter can be set to a value between 1 and 65535. Settings larger than 64 are not recommended for normal use. A low value will result in the fastest response to changes in gas concentration, a high value will result in a slower response. Note that the response is also determined by the diffusion rate into the sensor. The default setting is 32.

This chart shows the effect of changing the filter setting:

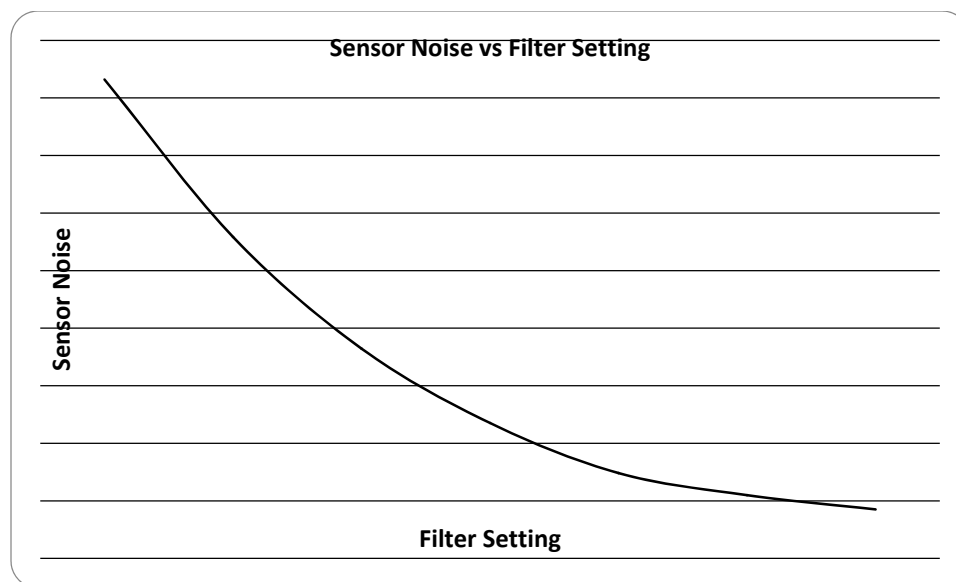

Increasing the filter setting has a beneficial impact on noise, so improves the sensor resolution. It also slows the sensor response to transients. This can be used to improve the detection of average CO2 conditions. In building control, for example, a fast response to breathing near the sensor is undesirable. If the transient response is important either for speed of response or because the shape of the transient is required, a low filter setting should be used.

The following chart shows the same transient event capture using a filter setting of 4, and using a filter setting of 32.

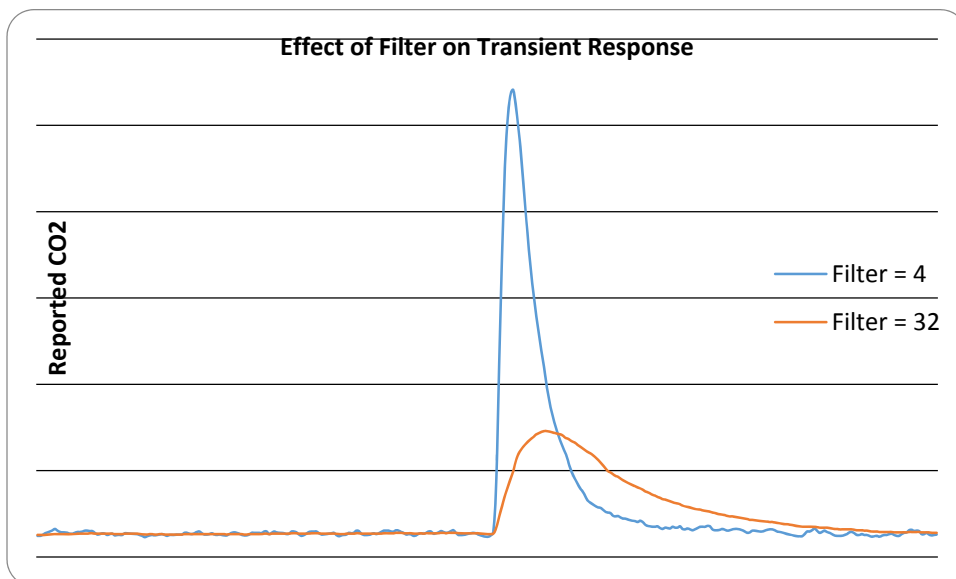

9.1.2 Setting the Digital Filter

To change the setting, type `A ###\r\n` where `###` is the required filter setting.

For most applications, a filter setting of 32 is recommended.

```
send:      A 32\r\n
response:  A 00032\r\n
```

If the filter is set to zero, a smart filter mode will be used in which the filter response is altered to suit the prevailing conditions. This is useful if there is a combination of steady state conditions, with some periods of rapidly changing concentrations.

9.1.3 Reading the Digital Filter Setting

The current setting for the digital filter can be determined by sending `a\r\n`

```
send:      a\r\n
response:  a 00032\r\n
```

9.2 User Options – EEPROM Settings

Some user settings can be altered in the internal EEPROM.

These settings can be set by using the parameter setting command “P”, and read using a lower case “p”. There are also 32 bytes of user EEPROM storage available.

9.2.1 Setting EEPROM

To set an EEPROM location, send

```
P ### ##\r\n
```

Where the first parameter is the address, and the second is the value.

Note that two byte values must be set one byte at a time.

For example, to change the default value of the ambient gas concentration used for ambient calibration (i.e. the assumed CO₂ concentration in fresh air) to 380ppm, send

```
send:      P 10 1\r\n
response:  P 00010 00001\r\n
send:      P 11 124\r\n
response:  P 00011 00124\r\n
```

9.2.2 Reading EEPROM

To read a parameter value from an EEPROM location, send “p #####\r\n” where ##### is the address of the parameter.

Note that two byte values must be read one byte at a time.

For example, to read the value of the ambient gas concentration used for ambient calibration (ie the assumed CO₂ concentration in fresh air)

```
send:      p 10\r\n
response:  p 00010 00001\r\n
send:      p 11\r\n
response:  p 00011 00124\r\n
```

9.2.3 EEPROM Settings

Most of the EEPROM settings are two byte values, indicated by HI and LO in the variable name in the following table. We recommend contacting GSS before altering the default values.

Location	Name	Purpose	Default Value
0	AHHI	Reserved	0
1	ANLO_	Reserved	0
2	ANSOURCE	Reserved	0

3	ACINITHI	Autocalibration Preload. This preloads the autocalibration timer so that the first autocalibration occurs after a shorter time.	87
4	ACINITLO	Low byte of above.	192
5	ACHI	Autocalibration Interval. Sets the time interval between autocalibrations.	94
6	ACLO	Low byte of above.	128
7	ACONOFF	Switches Autocalibration ON/OFF	0
8	ACPPMHI	Autocalibration Background Concentration. This determines what background CO ₂ level is assumed for autocalibration.	1
9	ACPPMLO	Low byte of above.	194
10	AMBHI	Ambient Concentration (for G command). This determines what background CO ₂ level is assumed for ambient calibration using the "G" command.	1
11	AMBLO	Low byte of above.	194
12	BCHI	Buffer clear time. This will clear any incomplete commands from the serial buffer after a fixed period of inactivity. The time is in half second increments.	0
13	BCLO	Low byte of above.	8
200-231		User EEPROM	255

9.2.4 Autocalibration Settings (locations 3-7)

These are included now to maintain compatibility with previous firmware versions. We recommend using the @ command to set autocalibration timings.

9.2.5 User EEPROM

Locations 200 to 231 can be used to store user values. Each location is a single byte. These locations are not used by the sensor.

E.g. to store the number 42 in the first user EEPROM location:

```
send:      P 200 42\r\n
response:  P 00200 00042\r\n
```

and to read it

```
send:      p 200\r\n
response:  p 00200 00042\r\n
```

Note that the EEPROM is only guaranteed for 100,000 write cycles.

10 Command Reference

This gives the complete command set for the COZIR™, SprintIR and MISIR sensors and illustrates use of some of the more commonly used options.

Key points to note are:

- In all cases, commands are terminated with a carriage return, line feed (“\r\n”).
- Commands are case sensitive.
- The commands use all use ASCII characters. Each command lists the ASCII letter and includes the hex code for avoidance of doubt.
- Always check for a correct response before sending another command.
- If a command is unrecognized, the sensor will respond with a “?”

WARNING

This document is provided to give a complete reference of the command set and outputs from the COZIR™ sensor. It is intended for advanced users only. If in doubt, please contact CO2Meter.com prior to use.

10.1 Customization

A COMMAND (0x41) **USER CONFIGURATION**

Example: `A 128\r\n`

Description: Set the value for the digital filter.

Syntax: ASCII character 'A', SPACE, decimal, terminated by 0x0d 0x0a (CR & LF) Response:
`A 00032\r\n`

a COMMAND (0x61) **INFORMATION**

Example: `a\r\n`

Description: Return the value for the digital filter.

Syntax: ASCII Character 'a' terminated by 0x0d 0x0a (CR & LF)
Response: `a 00032\r\n`

M COMMAND (0x4D) **USER CONFIGURATION**

Example: `M 212\r\n`

Description: Determines which values are going to be returned by the unit.

Syntax: "M", SPACE, followed by an up-to 5 digit number, each bit of which dictates which item will be returned by the sensor, terminated by 0x0d 0x0a (CR & LF).

Response: `M 212\r\n` (see “Output Fields” for details)

P COMMAND (0x50) **USER CONFIGURATION**

Example: `P 10 1\r\n`

Description: Sets a user configurable parameter.

Syntax: "P", SPACE, followed by an up to 2 digit number, SPACE followed by an up to 3 digit number, terminated by 0x0d 0x0a (CR & LF).

Response: `P 00001 00010\r\n` (see "User Settings" for details)

p COMMAND (0x70) **USER CONFIGURATION**

Example: `p 10\r\n`

Description: Returns a user configurable parameter.

Syntax: "P", SPACE, followed by an up-to 2 digit number, terminated by 0x0d 0x0a (CR & LF).

Response: `P 10 1\r\n` (see "User Settings" for details)

10.2 Information

Y COMMAND (0x59) **INFORMATION**

Example: `Y\r\n`

Description: the present version string for the firmware

Syntax: ASCII character 'Y', terminated by 0x0d 0x0a (CR & LF)

Response: `Y,Jan 30 2013,10:45:03,AL17\r\n`
`B 00233 00000\r\n`

NB This command returns two lines split by a carriage return line feed, and terminated by a carriage return line feed. This command requires that the sensor has been stopped (see 'K' command).

*** COMMAND (0x59)** **INFORMATION**

Example: `*\r\n`

Description: Returns a number of fields of information giving information about the sensor configuration and behavior.

Syntax: ASCII character '*', terminated by 0x0d 0x0a (CR & LF)

Response: Contact GSS for details.

. COMMAND (0x2E) **INFORMATION**

Example: `.\r\n`

Description: Returns a number indicating what multiplier must be applied to the Z or z output to convert it into ppm.

Syntax: ASCII character '.', terminated by 0x0d 0x0a (CR & LF)
Response: 00001\r\n" (this number is variable).

10.3 Switching between Modes

For discussion of different modes of operation, see the section "Operating Modes".

K COMMAND (0x4B) **USER CONFIGURATION**

Example: `K 1`
Description: Switches the sensor between the operating modes.
Syntax: ASCII character "K", SPACE, followed by the mode number, terminated by 0x0d 0x0a (CR & LF).
Response: `K 1\r\n` (the number mirrors the input value).

10.4 Zeroing and Calibration

See examples of each of the zero and calibration commands in the following section.

U COMMAND (0x55) **CALIBRATION – USE WITH CARE**

Example: `U\r\n`
Description: Calibrates the zero point assuming the sensor is in 0ppm CO₂.
Syntax: ASCII Character 'U' terminated by 0x0d 0x0a (CR & LF)
Response: `U 32767\r\n` (the number is variable)

G COMMAND (0x47) **CALIBRATION – USE WITH CARE**

Example: `G\r\n`
Description: Calibrates the zero point assuming the sensor is in 400ppm CO₂.
Syntax: ASCII character 'G'
Response: `G 33000\r\n` (the number is variable).

F COMMAND (0x46) **CALIBRATION – USE WITH CARE**

Example: `F 410 390\r\n`
Description: Calibrates the zero point using a known reading and known CO₂ concentration.
Syntax: ASCII character 'F' then a space, then the reported gas concentration then a space then the actual gas concentration.
Response: `F 33000\r\n` (the numbers are variable).

X COMMAND (0x58) CALIBRATION – USE WITH CARE

Example: `X 1000\r\n`

Description: Calibrates the zero point with the sensor in a known concentration of CO₂.

Syntax: ASCII character 'X' then a space, then the gas concentration.

Response: `X 33000\r\n` (the number is variable).

S COMMAND (0x53) CALIBRATION – USE WITH CARE

Example: `S 8192\r\n`

Description: Set the 'Altitude Compensation' value in EEPROM

Syntax: ASCII character 'S', SPACE, decimal, terminated by 0x0d 0x0a (CR & LF)

Response: `S 8192\r\n` (the number mirrors the input value).

s COMMAND (0x73) INFORMATION

Example: `s\r\n`

Description: Reports the Altitude Compensation value in EEPROM. See “**Altitude Compensation**”.

Syntax: ASCII Character 's' terminated by 0x0d 0x0a (CR & LF)

Response: `s 8193\r\n`

u COMMAND (0x75) USE ONLY WITH CO2Meter.com GUIDANCE

Example: `u 32767\r\n`

Description: Send a zero set point.

Syntax: ASCII character 'u', SPACE, decimal, terminated by 0x0d 0x0a (CR & LF)

Response: `u 32767\r\n`

NB For advanced use only. Contact GSS before using this command.

There are three variants of the autocalibration configuration command:

@ COMMAND (0x40) INFORMATION

Example: `@\r\n`

Description: Return the autocalibration settings

Syntax: ASCII character '@' terminated by 0x0d 0x0a (CR & LF)

Response: `@ 1.0 8.0\r\n` (if autocalibration is enabled).

`@ 0\r\n` (if autocalibration is disabled).

@ COMMAND (0x40) **CALIBRATION – USE WITH CARE**

Example: @ 0\r\n

Description: Switch off the autocalibration function

Syntax: ASCII character '@' followed by a SPACE followed by a zero terminated by 0x0d 0x0a (CR & LF)

Response: “ @ 0\r\n”

@ COMMAND (0x40) **CALIBRATION – USE WITH CARE**

Example: @ 1.0 8.0\r\n

Description: Set the Autocalibration timing

Syntax: See “**Autocalibration**” section

Response: @ 1.0 8.0\r\n (the number mirrors the input value).

10.5 Polling Commands

H COMMAND (0x48) **INFORMATION**

Example: H\r\n

Description: Reports the humidity measurement from the temperature and humidity sensor (if fitted). Divide by 10 to get the %RH

Syntax: ASCII Character 'H', terminated by 0x0d 0x0a (CR & LF)

Response: H 00551\r\n

T COMMAND (0x54) **INFORMATION**

Example: T\r\n

Description: Reports the humidity measurement from the temperature and humidity sensor (if fitted). Subtract 1000 and divide by 10 to get the temperature in °C.

Syntax: ASCII Character 'T', terminated by 0x0d 0x0a (CR & LF)

Response: T 01224\r\n

Z COMMAND (0x5A) **INFORMATION**

Example: Z\r\n

Description: Reports the latest CO2 measurement in ppm.

Syntax: ASCII Character 'Z', terminated by 0x0d 0x0a (CR & LF)

Response: Z 00512\r\n

Q COMMAND (0x51)

INFORMATION

Example: `Q\r\n`

Description: Reports the latest measurement fields as defined by the most recent 'M' command.

Syntax: ASCII Character 'Q', terminated by 0x0d 0x0a (CR & LF)

Response: `H 12345 T 12345 Z 00010\r\n`

11 Appendix A: Power Consumption

The COZIR family of sensors offers low power CO₂ sensing using patented GSS sensor technology. COZIR sensors are available over the whole measurement range from 400ppm to 100%.

COZIR sensors have been optimized for use in battery power applications where the short startup time and low power consumption offer very significant advantages over standard NDIR sensing technology. Because of the very rapid power-up time, COZIR sensors are also being used in energy scavenged applications, using power sources such as PV cells, where it is essential to minimize the energy used per measurement.

This document considers the best methods to use in applications where energy is limited.

There are three distinct ways to operate the sensor:

Continuous Power, Continuous Measurement (3mW-3.5mW)

COZIR sensors are designed for continuous power operation. The typical power consumption is 3mW in polling mode, and 3.5mW in streaming mode. In these modes, the sensor is constantly measuring, two fresh measurements per second (COZIR, MSIR, MiniIR) or 20 times per second (SprintIR). In streaming mode, all measurements are transmitted. In polling mode, measurements are only transmitted when requested.

Continuous Power, Interrupted Measurement (power depends on usage)

Switching to a low power command mode (150μW³) between measurements greatly reduces the average power consumption, though with some loss of functionality.

Power Cycled Operations (power depends on usage)

Short startup allows power cycling which gives the lowest power consumption. There is some loss of functionality which must be addressed by the user.

Operation	Measurements	Power Consumption ¹	Autocalibration Available
Streaming	2/20 per sec.	3.5mW	Yes
Polling	2/20 per sec.	3.0mW	Yes
Command Mode	on demand	270μW ^{*3}	Yes, but with modification.
Power Cycling	on demand	120μW [*]	User Routine

^{*}Power consumption based on 1 reading every 5 minutes, sensor powered for 10s per reading

11.1 Operating Modes – Power Levels

There are three operating modes available in the COZIR range of sensors. Users can switch between modes using the ‘K’ command (see *COZIR Software User’s Guide* for details).

11.2 Streaming Mode (K 1)

This is the factory default. Measurements are made and transmitted twice per second for COZIR, MISIR and MinIR sensors, and 20 times per second for SprintIR sensors..

To enter Streaming mode, send `K 1\r\n`²

The power consumption is approximately 3.5mW¹

11.3 Polling Mode (K 2)

In this mode, data is not transmitted until requested, however the sensor continues to make measurements twice per second for COZIR, MISIR and MinIR sensors, and 20 times per second for SprintIR sensors.

To enter Polling mode, send `K 2\r\n`

The typical power consumption in this mode is 3.0mW when data is not being polled, and 3.5mW when data is polled.

11.4 Command Mode (K 0)

In command mode, no measurements are made or reported. This mode is primarily intended to be used when interacting with the sensor, for example to read the serial number, to determine the status or to set output mask or filter values. It can be used to reduce the power consumption by reducing the power level when measurements are not required. Users looking for the lowest power applications should consider powering down the sensor rather than using command mode to save power.

To enter command mode, send `K 0\r\n`

The typical power consumption in command mode is 150μW³.

11.5 Current Profile

Streaming mode and Polling mode are very similar. There is a very short initial inrush current at the start of each measurement cycle. The peak is typically 33mA, and is present for less than 1mS. GSS recommends that the sensor supply circuit is capable of supplying a peak of 100mA.

Each measurement cycle lasts 30ms-40ms depending on the number of output fields being transmitted. Between measurements cycles, the power consumption reduces to $150 \mu\text{W}^3$.

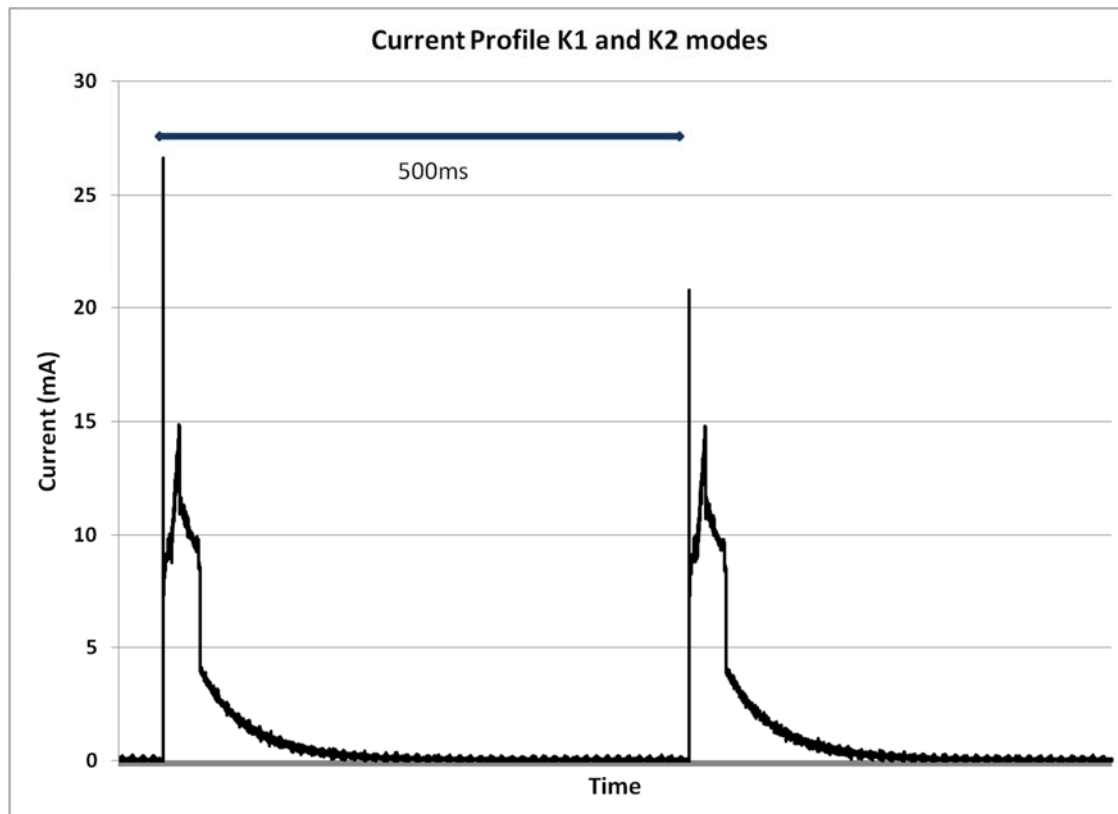

11.6 Warm-up Time

When the sensor is powered up initially, or when it is switched from command mode, it must run through a short warm-up period.

The COZIR warm-up time comprises two parts; start-up cycle, and signal processing delay.

The start-up cycle takes 1.2s, during which time the sensor will use approximately 6mJ of energy. The first readings are transmitted by the sensor in streaming mode immediately following the start-up cycle. The signal processing delay depends on user settings. The sensor has a low pass digital filter which smoothes the CO₂ reading (reported in the filtered CO₂ output -Z). It takes some time for the digital filter to reach a final value. This time depends on the digital filter setting, which is user configurable. To set the digital filter, use the A command:

```
A #\r\n
```

where # is the digital filter setting (see *COZIR Software Users Guide* for more Information).

The warm-up time must be long enough to allow the filter response to reach a final value. The required warm-up time in seconds is approximately equal to the filter value.

Filter Setting	Warm-up Time
1	1.2s
2	3s
4	5s
8	9s
16	16s
32	32s

The graph shows a typical start-up from command mode or from power up (there is no difference). In this case, the digital filter value was 8. In this case, the digital filter setting was 8.

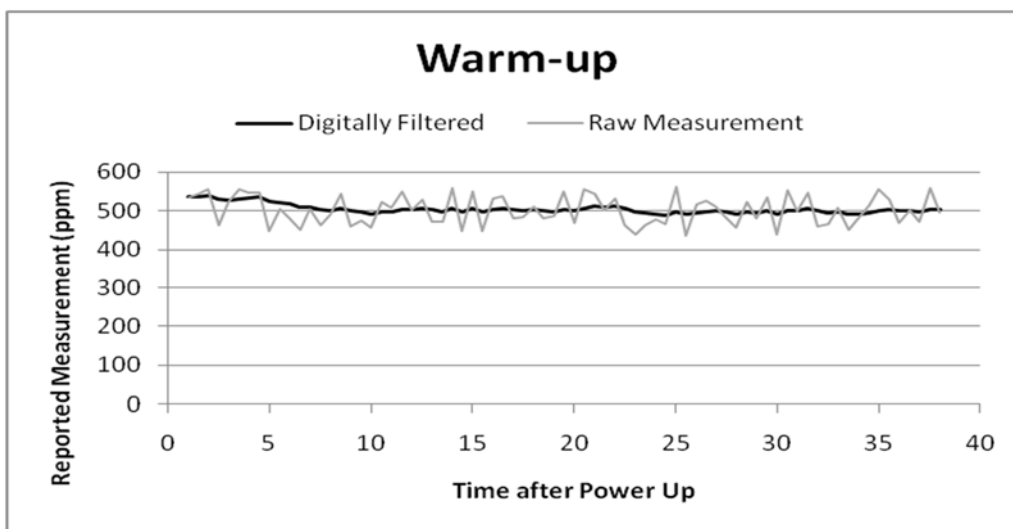

The choice of filter setting is a trade-off between reducing noise and reducing power (higher filter = lower noise, lower filter = shorter warm-up).

These shows the same sensor data, but with filter settings of 1,4 and 8, and the corresponding warm-up period. The figure graphed is the CO₂ reading reported by the sensor at the end of the warm-up period.

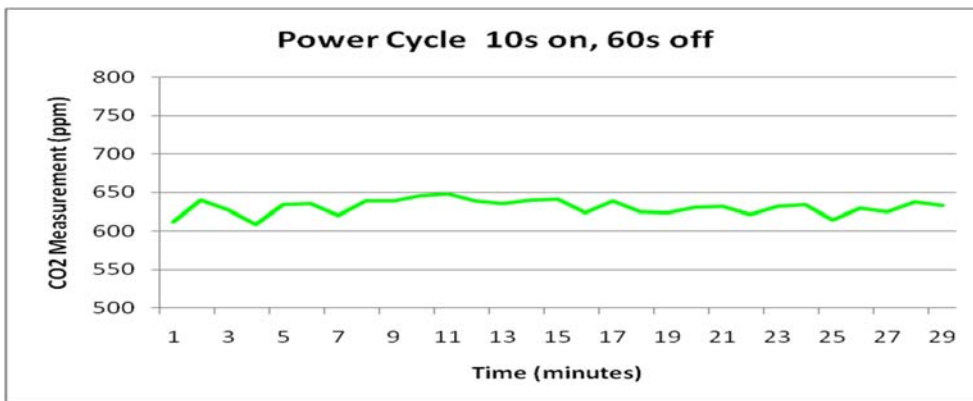
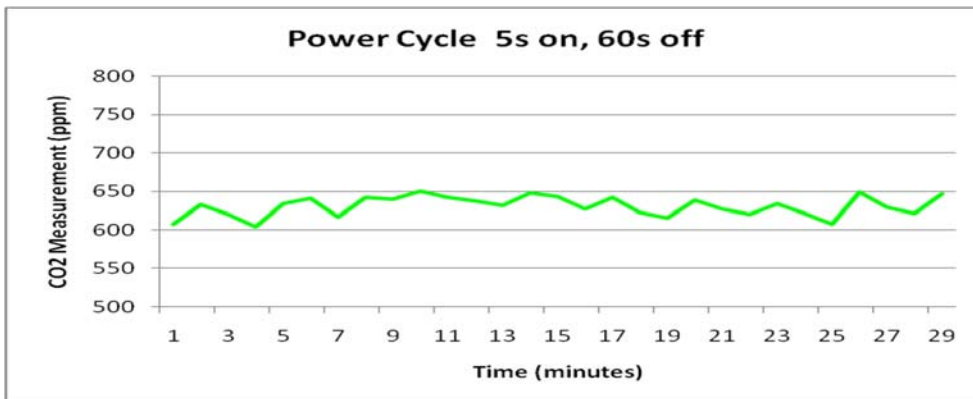
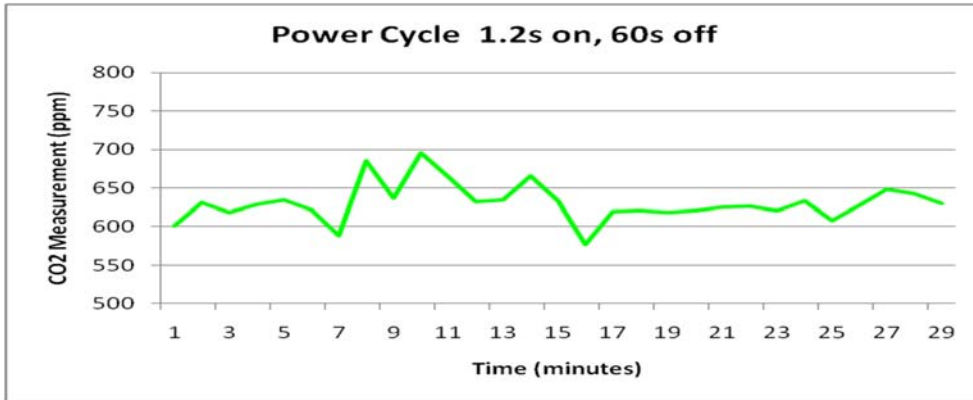

11.7 Minimizing the Power in Streaming and Polling Modes

Both polling and streaming are continuous power modes, using 3mW-3.5mW. The power consumption and measurement cycle cannot be varied in these modes, so the user must simply focus on minimizing any options on the sensor. The lowest power is achieved by reporting one value only, the CO₂ measurement.

Additional features will increase the power consumption, for example, temperature and humidity measurement, voltage output, or additional output fields. These should be avoided in low power applications.

11.8 Polling and Streaming Key Points

- Use polling mode to minimize transmission time. This will reduce the average power consumption by approximately 0.5mW, depending on the polling frequency.
- Ensure that only necessary output fields are turned on to minimize the measurement Tx time. Use the M command to configure the output fields. To return the filtered CO₂ value only (recommended) send M 4\r\n to the sensor. Each additional output field will add approximately 0.25mW to the total power consumption.
- Use the digital output from the sensor only. The voltage output (optional fit) increases the power consumption.
- The temperature and Humidity sensor (optional fit) increases the power consumption by approximately 1mW.
- The lowest achievable power using continuous measurements is approximately 3mW.
- All functionality is preserved and the sensor will be fully responsive to commands at all times.

11.9 Minimizing Power using Command Mode

It is possible to reduce the power consumption by switching the sensor into command mode between measurements. The power consumption in command mode is only $150\mu\text{W}^3$, much lower than either polling or streaming data.

This is simple to implement using the COZIR commands:

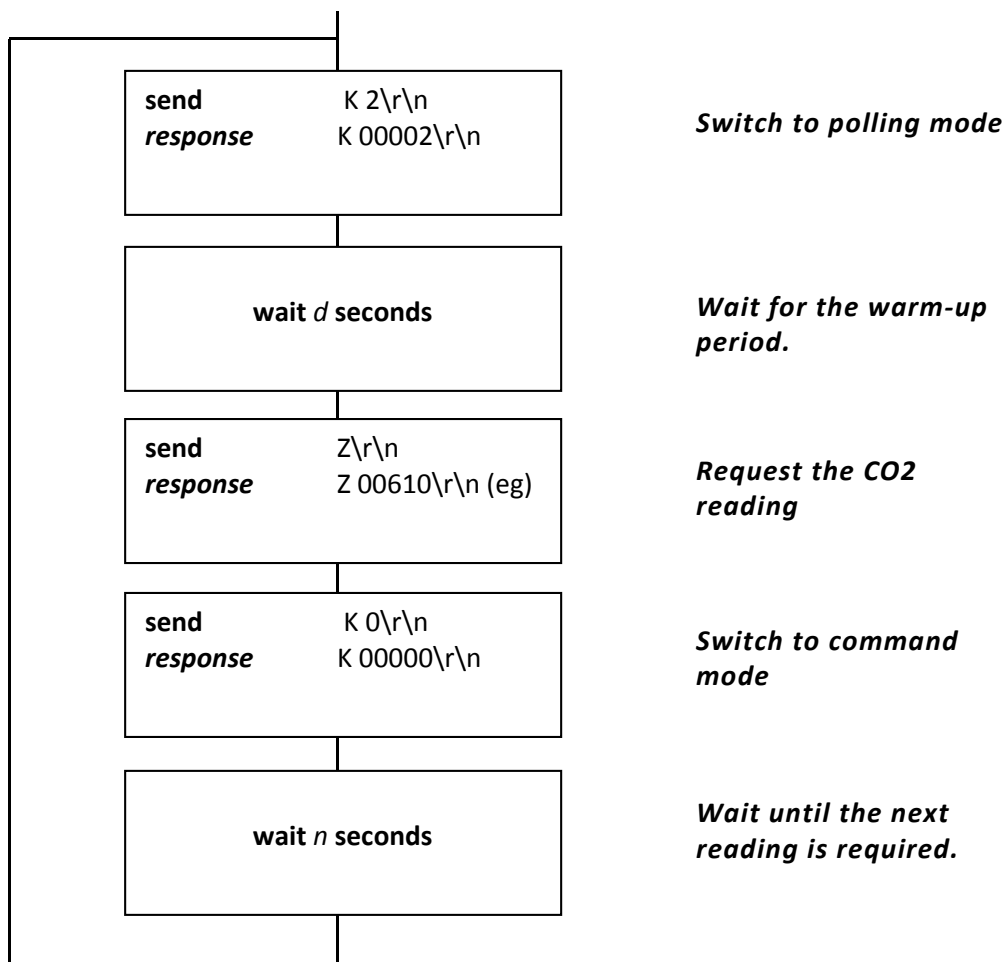

where:

d is the warm-up delay

and

n+d is the gap between measurements

This method offers much lower average power than conventional power up modes, though with some loss of functionality.

11.10 Command Mode Power Reduction Key Points

- When exiting from command mode, the sensor must run through the same warm-up period as a newly powered sensor. See the warm-up section for details and recommended times.
- None of the zeroing functions are operational in command mode.
- The autocalibration process is timed by measurement cycles. As measurement cycles are suspended in command mode, the auto-calibration period must be adjusted to take account of the decreased number of measurements. For example, if the sensor is used in command mode, and powered up for only 10s every 5 minutes, the autocalibration counter will run 30x slower than in streaming or polling mode, so the autocalibration period should be adjusted to reflect that. See *COZIR Application Note Auto-Calibration* for details of the autocalibration set-up.
- The power level will depend on the duty cycle of the sensor. It will typically be possible to achieve levels of less than 300 μ W.
- The digital filter will retain the last reading when switching into command mode, and use this as its initial value when the sensor measurement is switched on again (filtered output only). If there is a very large step change between readings, the filter may not reach a final stable value in one warm-up cycle. Users can avoid this potential issue by implementing their own signal conditioning using the unfiltered (z) output from the sensor.
- The sensor will always power up in Streaming or Polling mode (whichever was the last selected). It will not power up in command mode – this has to be selected by the user.

11.11 Minimizing Power by Power Cycling

When there are very low levels of power available, for example using a PV cell, the best option is to power down the sensor between measurements. Because of the short warm-up times, this approach can be used to run sensors indefinitely from a solar cell, or for many years from a small primary cell.

The user must address zero point calibration (autocalibration) see below.

The typical implementation is:

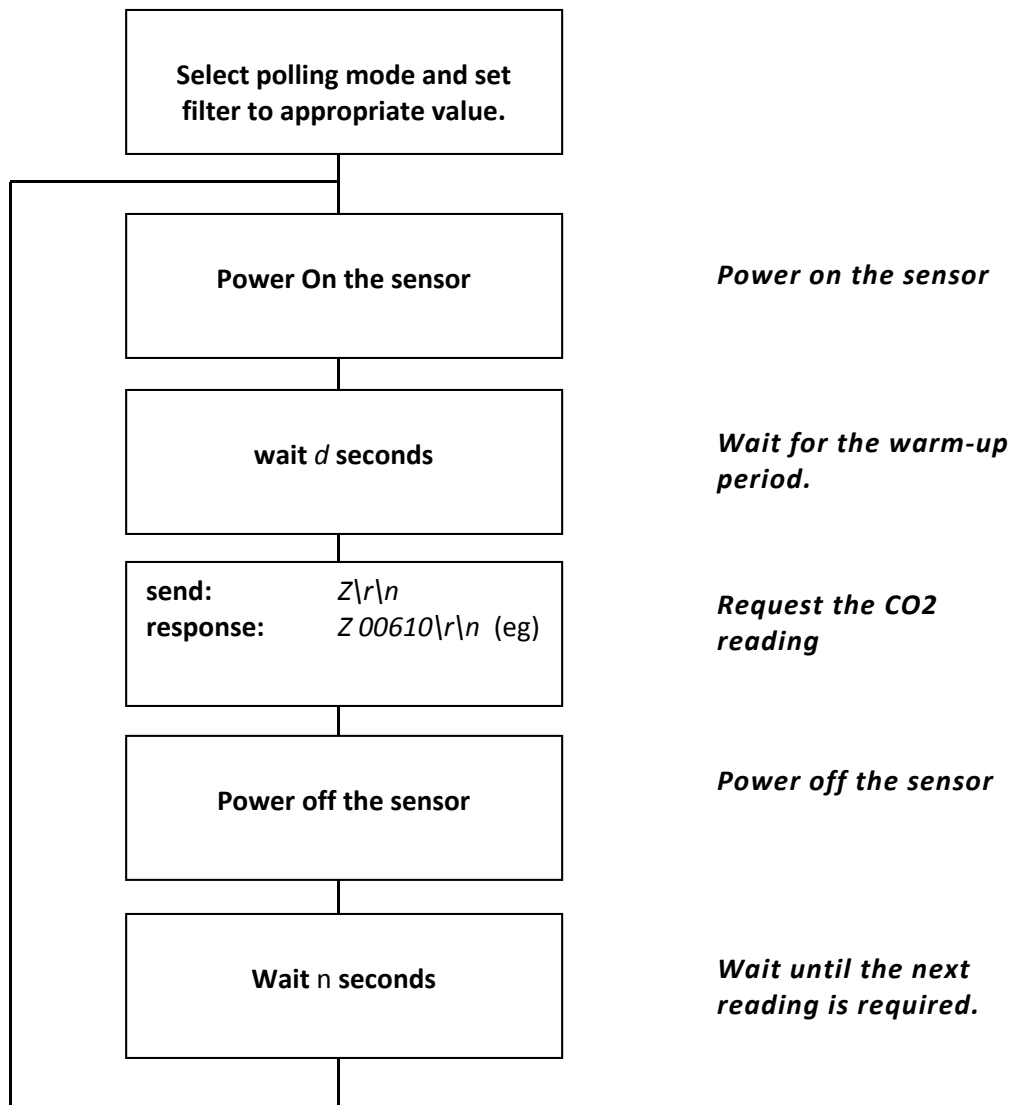

11.12 Power Cycling Key Points

- Ensure that the sensor is configured for polling mode.
- Ensure that the filter setting matches the planned power on period.
- COZIR sensors will store configuration information in non-volatile memory, so this does not need to be refreshed when the sensor is powered up.
- On each power up, the sensor must run through the same warm-up period. See the warm-up section for details and recommended times.
- The autocalibration is disabled when the sensor is powered down, and the autocalibration timers are reset on power up. Users must implement their own autocalibration routine when power cycling. See *Implementing a User Autocalibration Routine*.
- The power level will depend on the duty cycle of the sensor.
- The power switch to the sensor must ensure that the sensor power supply requirements can be met, in particular, the peak current requirement (33mA) and minimum voltage (3.2V).

11.13 Implementing a User Auto-Calibration Routine

COZIR sensors have an autocalibration feature which uses background tracking to provide long term stability for the sensor. This feature is disabled when the sensor is power cycled, or switched to command mode, and the responsibility for this routine switches to the user.

It is possible to calibrate the sensor using the standard zeroing commands.

In many cases, it is preferable to implement a version of autocalibration which recalibrates the sensor zero point using the CO₂ background of approximately 400ppm to recalibrate the sensor zero point. This relies on the sensor being exposed to fresh air at least once during the calibration interval. For many applications, this condition is met overnight or during weekends when buildings are little occupied.

The COZIR sensor has a zero calibration option designed to allow users to implement an autocalibration routine when the sensor is not continuously powered.

First, select a calibration period. The choice of period should be long enough to ensure exposure to fresh air, so should usually be no less than one week.

Next, select the value of background CO₂ expected. COZIR sensors have a default of 400ppm, but users can select any value.

Now review the sensor output during the calibration period and note the lowest CO₂ value recorded. This is assumed to be ambient levels.

Finally, send a correction to the sensor to instruct it that this level should be corrected to read the background CO₂ level. This uses the COZIR “F” command.

This command has the format `F ##### *****\r\n`

Where `#####` is the reading displayed by the sensor, and `*****` is the corrected reading.

For example, if the lowest reading measured over 3 weeks was 415ppm, and the user wants to correct that to read 400ppm, the command would be `F 415 400\r\n`.

Note that this command can only be used once on a set of historic readings. To repeat the F command, a new set of readings must be generated.

Notes

¹ Power measurements are typical values for sensors measured at GSS at room temperature. Unless otherwise stated, power levels assume that each measurement comprises a CO₂ measurement only. The optional humidity sensor and voltage output will increase the power consumption. The power consumption will increase with temperature.

² Throughout this document, `\r\n` is used to signify the ASCII characters Carriage Return and Line feed, 0x0d, 0x0a.

³ Power levels in command mode vary with temperature. This is due to increased current in some of the individual components. The power level at 50°C can be 2x the power level at 20°C

12 Appendix B: Analog Voltage Output

Before selecting the voltage output, please consider:

- **The voltage output is derived from the digital output (it is a PWM driven).**
- **A digital interface is required to configure the COZIR.**
- **Even if the end application will use only a voltage interface, we recommend that designers use a digital interface (eg GSS USB to serial cable) when evaluating the sensor.**
- **The voltage output is for CO₂ measurement only. Temperature and humidity outputs (optional) are only available as digital (UART) outputs.**

The COZIR™ range of sensors can be fitted with an optional voltage output in addition to the standard digital (UART) output. This is available to facilitate interfacing to legacy systems which can only handle a voltage input. GSS recommends that a digital sensor is used wherever possible.

The voltage output is proportional to the CO₂ concentration.

Key points to note are:

- The maximum voltage output (full scale) will always be that applied to pin 3 of the 10 way connector.
- Care must be exercised in selecting the load resistance connected between the voltage output (pin 9) and GND (pin 1)
- The voltage output pin (pin 9) is an output pin only. Take care not to feed any voltage/current into the voltage output pin.
- The voltage output is a factory fit option. It is not present unless requested.
- The supply voltage should be 3.3V+/- 0.1V. The sensor will continue to operate up to 5V, however the voltage output is valid only when the supply is in the range 3.2V to 3.4V.

12.1 Ordering Information

The voltage output is default for reading CO₂ levels on COZIR sensors without RH/T. It is not available on COZIR sensors that include RH/T, or SprintIR sensors.

All MISIR sensors have a voltage output. This operates in the same way as the COZIR voltage output, except that the full scale voltage is 3V, regardless of the supply voltage.

12.2 Voltage Output Connections

The voltage output is available on pin 9 of the sensor. Power and ground must be applied to pins 1 and 3.

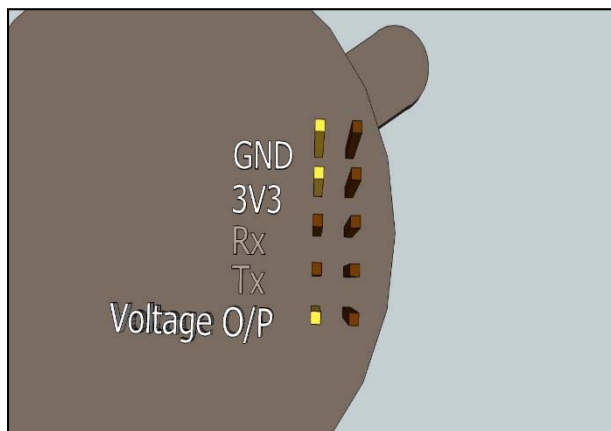

COZIR-A Series Connections

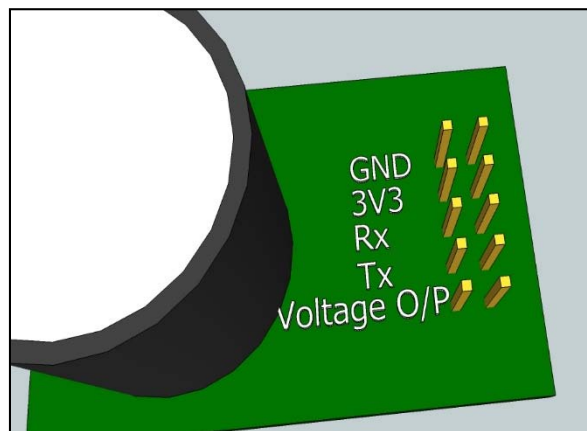

COZIR-W Series Connections

12.3 Load Impedance

The COZIR™ voltage output pin has an internal resistance of approximately 150Ω. The internal capacitance between the voltage output pin and 0V is 220nF. This gives the output a single order high frequency roll off at about 4.8kHz.

To avoid loading issues affecting the measurement, it is essential to ensure that load connected to the voltage output pin (9) is greater than 10kΩ and preferably greater than 100kΩ.

Load Resistance	Loading Error
4k7	3%
10k	1.5%
100k	0.1%
500k	0.03%

12.4 Converting Voltage to Concentration

The voltage output is provided by Pulse Width Modulation (PWM) of the sensor supply voltage. This means that all voltage outputs are relative to the supply voltage. For example, if the supply voltage is 3.4V, then the full scale output from the voltage pin will also be 3.4V, the half scale voltage will be 1.7V etc.

To convert a voltage into a CO₂ concentration:

$$\text{Concentration} = FS * V_{out} / V_{supply}$$

Where

$$FS = \text{Full Scale Concentration}$$

V_{out} = voltage output (at pin 9)

V_{supply} = supply voltage (at pin 3)

All voltages relative to GND (pin 1)

Note that there is a slight zero offset (see below) which should be taken into account for readings below 10% of the Full Scale.

12.5 Linearity of the Voltage Output

Figure 2 shows a typical plot of output voltage (at pin 9) vs CO₂ concentration.

- Note that the output voltage is linearly dependent on the CO₂ concentration measured by the sensor.
- Note also that for CO₂ concentrations less than 10% of full scale, the sensor output voltage is affected by the output Operation Amplifier offset voltage (~14mV). See below.

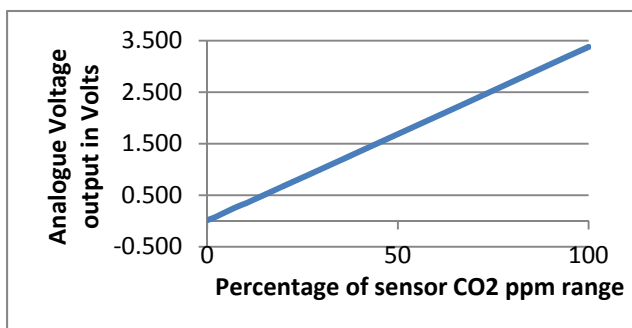

Output Linearity (This graph assumes a supply voltage of 3.3V)

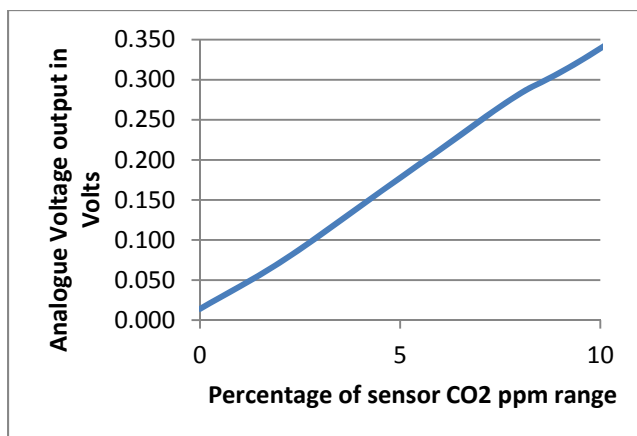

Effect of zero offset close to 0. (This graph assumes a supply voltage of 3.3V)

12.6 Noise on the Voltage Output

The typical noise present on the voltage output is as follows with the voltage output at half full scale:

- 140µVrms measured in a 20kHz bandwidth.
- 450µVrms measured in a 10MHz bandwidth.
- In a 10MHz bandwidth the highest noise voltage amplitude is at least 70dB below the desired DC output voltage.

12.7 Changing the Full Scale Concentration

The full scale concentration of the sensor can be changed via some user settings. **Note that the full scale concentration must be equal to or lower than the sensor range.**

For example, the scaling of a 5% sensor can be changed so that the voltage full scale represents 4% or 1%.

This must be set using the digital (UART) interface to the sensor, using the P command to set the values in the Sensor EEPROM. This is stored in non-volatile memory, so need only be changed once, not every time the sensor is powered. These are stored in EEPROM using the P command.

The format of the commands required are:

P 0 highbyte\r\n

P 1 lowbyte\r\n

The full scale value is stored as a two byte number. The target concentration must first be split into two bytes:

highbyte = int(concentration/256)

*low byte = concentration%256 (= concentration – highbyte*256)*

For example, to change a 5000ppm sensor FS to 2000

Highbyte = int(2000/256) = 7

Low Byte = 2000%256 = 208

and the relevant commands and responses are:

send: P 0 7\r\n

response: p 00007 00007\r\n

send: P 1 208\r\n

response: p 00001 00208\r\n

Note that concentration **MUST** be expressed in the units used by the sensor. For COZIR-A(ambient) and MISIR, the units are ppm. For COZIR-W(Wide Range), the units are ppm/10. For 100% range sensors, the units are ppm/100.

Examples:

Target Full Scale	Type	High Byte	Low Byte	P Commands
2000ppm	COZIR-A	7	208	P 0 7 P 1 208
5000ppm	COZIR-A	19	136	P 0 19 P 1 136
10000ppm (1%)	COZIR-A	39	16	P 0 39 P 1 16
10000ppm (1%)	COZIR-W	3	232	P 0 3 P 1 232
5%	COZIR-W	19	136	P 0 19 P 1 136
10%	COZIR-W	39	16	P 0 39 P 1 16
70%	COZIR-W (100% range)	27	88	P 0 27 P 1 88

Warning. If the full scale value is set higher than the sensor range (ie the range when first supplied) the voltage values will be incorrect and must not be used.

12.8 Digital outputs

The digital (serial) Rx and Tx connections are still available and active when the voltage output is fitted. This allows the sensor to be calibrated and configured over the serial connections.

12.9 Zero Point Calibration

The serial communication options are also available. The COZIR sensor requires periodic zero point calibration. In many cases, this can be done automatically using the built in auto-calibration option.

Additionally, two zero calibration pins area available.

Nitrogen Zero (Pin 8)

This pin is normally high. Hold it low for 1.5s to trigger a nitrogen zero. This assumes that the sensor is free from any CO2.

Ambient Zero (Pin 10)

This pin is normally high. Hold it low for 1.5s to trigger an ambient zero. This assumes that the sensor is in fresh air (default setting is 450ppm).

13 Appendix C: Setting the Auto-Calibration Parameters for Older Firmware

Older COZIR and SprintIR sensor firmware set the auto-calibration parameters directly into the EPROM memory locations 3-7 using the P and p commands. These are included now to maintain compatibility with previous firmware versions. We recommend using the @ command instead of the P command to set auto-calibration timings

13.1 Environmental Requirements for Auto-calibration

Exposure to Fresh Air

The sensor must 'see' fresh air at least once during the auto-calibration period. You do not need to know when the fresh air will be sensed, just that it will be sensed at some point during the period.

Continuously Powered

The auto-calibration information is deleted when the sensor is switched off. This ensures that each installation is unaffected by any previous history of the sensor. For auto-calibration to function, it must be power on for the whole of the auto-calibration period.

13.2 Auto-calibration using GasLab®

The simplest way to set up a sensor for auto-calibration is to use the Gaslab® software. You can download GasLab® here: <http://www.co2meter.com/pages/downloads>

The next sections show how to set up the auto-calibration using Hyper Terminal or your own software.

13.3 Setting the Auto Calibration Parameters

Three parameters are required to enable the auto-calibration routine:

Auto-calibration period

This determines how often the auto-calibration takes place.

Background Concentration

Typically 400-450ppm. This is the level the sensor will use as background.

Initial Auto-calibration Period

It is possible for the first auto-calibration to take place more quickly than the regular auto-calibration event. This can be useful to stabilize quickly after installation.

Before setting the auto-calibration parameters, please note the following:

- Before altering the auto-calibration parameters, switch the sensor into command mode:
send

K 0 <CR><LF>

This stops the measurement process in the sensor.

- All commands must be terminated with `\r\n` (carriage return, line feed). NB HyperTerminal does not add the line feed character as standard. The ASCII Setup must be configured to append line feeds.
- For details on the commands used, please consult the *“COZIR Software Interface Guide”*
- For an example of a typical setting, see *Auto-calibration Example*.

13.4 Background Concentration

The background concentration depends somewhat on the area the sensor is installed. Typically, a figure between 400ppm and 450ppm is used.

To set this, send

`P 8 x \r\n`

`P 9 y \r\n`

where x and y depend on the concentration you want to set.

Concentration	x	Y
380	1	124
400	1	144
425	1	169
450	1	194

This is stored as a two byte value, the high byte being in location 8 and the low byte in location 9. The value represents the concentration.

To calculate other values,

$x = \text{int}(\text{concentration}/256)$

y = the remainder after dividing concentration/256

13.5 Auto-calibration Interval

To set the auto-calibration interval, send

`P 5 x \r\n`

`P 6 y \r\n`

where x and y depend on the auto-calibration interval you want to set.

Interval	x	y
1 week	47	64
2 weeks	94	128
3 weeks	141	192

This is stored as a two byte value, the high byte being in location 5 and the low byte in location 6. The value represents the number of counts between auto-calibration events, where each count lasts 50 seconds.

To calculate other values,

$a = \text{auto-calibration period (in days)} * 1728$

$x = \text{int}(a / 256)$

$y = \text{the remainder after dividing } a/256$

13.6 Initial Auto-calibration period

To set the initial auto-calibration period

P 3 x \r\n

P 4 y \r\n

If the first auto-calibration event is to occur at the regular auto-calibration period, set both x and y to 0.

Otherwise, x and y must be calculated using the desired initial auto-calibration time and the regular auto-calibration period.

If the first auto-calibration event is to occur at the regular auto-calibration period, set both x and y to 0.

Otherwise calculate as follows:

$a = \text{auto-calibration period (in days)}$

$b = \text{initial auto-calibration period (in hours)}$

$c = (a * 24 - b) * 72$

$x = \text{int}(c / 256)$

$y = \text{the remainder after dividing } c / 256$

The Initial auto-cal period works by preloading the auto-cal period count. So the value stored is the auto-calibration period *minus* the initial auto-cal period. Both are measured in auto-cal counts, where a count is 50s.

To disable, set the initial auto-cal period to 0.

This is stored as a two byte value. the high byte being in location 5 and the low byte in location 6. The value represents the number of counts between auto-calibration events, where each count lasts 50 seconds.

13.7 Auto-Calibration Examples

This give two example of typical auto-calibration settings.

Example 1

To set auto-calibration to take place every week, with the first auto-calibration event taking place 36 hours after power-up. The background level is assumed to be 450ppm:

K 0
P 7 0
P 3 37
P 4 32
P 5 47
P 6 64
P 8 1
P 9 194
P 7 1

Then switch the sensor off for 30 seconds and on again.

Example 2

To set auto-calibration to take place every 3 weeks, with no initial auto-calibration. The background is assumed to be 420ppm:

K 0
P 7 0
P 3 0
P 4 0
P 5 141
P 6 191
P 8 1
P 9 164
P 7 1

Then switch the sensor off for 30 seconds and on again.